

T A B L E O F C O N T E N T S

SPECIAL APPLICATIONS SECTION

PART	DESCRIPTION	PAGE
1	<u>OVERVIEW</u>	1.1.1
2	<u>APPLICATIONS</u>	
	2.1 <u>INDIVIDUAL STATION PAGE</u>	2.1.1
	2.2 <u>CALLER ID</u>	2.2.1
	2.3 <u>USING LCR TO INSERT LONG DISTANCE PIC CODE</u>	2.3.1
	2.4 <u>USING LCR WITH CALLER ID</u>	2.4.1
	2.5 <u>UNIFORM CALL DISTRIBUTION</u>	2.5.1
	2.6 <u>OfficeServ 7100 VoIP (VOICE OVER INTERNET PROTOCOL)</u>	2.6.1
	2.7 <u>NETWORKING OVER PRI</u>	2.6.1
	2.8 <u>NETWORKING OVER IP</u>	2.7.1
	2.9 <u>NETWORKING</u>	2.8.1
	2.10 <u>OfficeServ CONNECT AND MOBEX</u>	2.9.1
	2.11 <u>SIP CONNECTIVITY TO THIRD PARTY ATA DEVICES</u>	2.10.1

PART 1. OVERVIEW

This part of the technical manual is titled “Special Applications” because it provides information about interfacing with customer-provided equipment or using a feature in a different way than it was intended. Perhaps an application may require a combination of CPE, creative programming, unusual feature operation or all of the above.

Because these applications require installation instructions and a combination of programming sequences, there is no obvious place to put this information; therefore, we created this part of the manual. As additional special applications are reported from the field, we will include them in this section.

PART 2. APPLICATIONS

2.1 INDIVIDUAL STATION PAGE

The system was not designed to permit page announcements to individual keysets. However, a forced auto answer key (FAUTO) can be used to accomplish this objective.

1. Program a keyset for RING [in MMC 103](#).
2. Assign an FAUTO key to each keyset that is allowed to page individual keysets.
3. Call another station. When you hear ringback tone, press the FAUTO key. The ringing will stop and an Auto Answer call is set up.

NOTE: To prevent the use of this feature from getting out of control, only assign FAUTO keys to those keysets needing to page individual keysets.

2.2 CALLER ID

The OfficeServ 7100 is compatible with both types of Caller ID as defined by BELLCORE. These are the single message format or "Number Only" sometimes referred to as standard Caller ID and the multiple message format or "Name and Number" sometimes referred to as Deluxe Caller ID. In the case of Number Only delivery, there is a translation table available that may be used to add names to the delivered number.

HARDWARE PROVISIONS

A 4TRM trunk module

SOFTWARE PROVISIONS

The MMCs related to Caller ID are listed below with a short description of their use. They are listed in the recommended order in which they should be programmed. This sequence is suggested so that the installer gets a better understanding of how the feature works. There is no technical reason to follow this sequence.

[MMC 414 CALLER ID TRUNKS](#)

This MMC is used by the technician to determine which trunks will receive Caller ID data.

[MMC 312 ALLOW CALLER ID](#)

This MMC is used by the technician to determine which keysets are allowed to receive Caller ID displays.

[MMCs 722 and 723](#)

These MMCs have keys related to Caller ID features added to them. It is strongly recommended that all keysets allowed Caller ID in MMC 312 are programmed with a CID key.

[MMC 728 CID TRANSLATION](#)

This MMC allows the technician to create a list of names that correspond to numbers received from the Central Office. These names will be displayed when a call rings in that has NUMBER ONLY data provided by the CO.

[MMC 725 SMDR OPTIONS](#)

The ability to print Caller ID data and abandoned calls is determined by this MMC.

[MMC 119 CALLER ID DISPLAY](#)

The OfficeServ 7100 will display both Caller ID Name and Number simultaneously on the display the keysets. This MMC is used by the end user to determine which piece of Caller ID data is displayed

when a call rings at the user's station. This MMC is primarily used when displaying transferred calls.

[MMC 501 SYSTEM TIMERS](#)

This MMC has two new timers related to Caller ID. The only timer that may need adjustment is the CID DISPLAY TIME. This is the length of time that CID data is displayed after the CID key is pressed.

[MMC 415 TRK. ABANDON](#)

This MMC is used by the technician to determine which trunks will record data in the Call Abandon list and print with an Abandon "A" flag on SMDR.

[MMC 608 ASSIGN REV BLOCK](#)

This MMC is used by the technician to assign CID Review blocks to keysets to allow the user to review CID data for previous calls.

[MMC 701 ASSIGN COS](#)

All of the Caller ID features have been added to this MMC to enable the technician to allow or deny them.

[MMC 724 NUMBER PLAN](#)

The Caller ID features have been added to this MMC to allow a technician to assign an access code where necessary.

In addition to the above MMCs, it is necessary to have LCR programmed on the system to enable certain features with a DIAL/REDIAL option to be used. This is because the number format provided by the Central Office contains the area code. This area code must be stripped off in the LCR modified digits section to allow a local number to be correctly dialed.

For example, if the system is located in the 305 area code, the LCR digit table points the entry 1305 to a modified digits entry that deletes the first four digits of the CID number. Of course, this is a much simplified LCR scheme. As there are long distance calls to be made within the home area code, additional entries are required to identify these.

For example, if 1305-426 is a local call, the area code has to be stripped, but if 1305-858 is long distance, the area code has to remain to allow the number to be dialed. There are two ways of doing this. You can either enter all of the local office codes and tell the system to strip the area code from them or you can enter the long distance codes and tell them to ignore the modify digits entry.

A list of all of the local office codes can be found at the front of the local telephone directory.

2.3 USING LCR TO INSERT LONG DISTANCE PIC CODE

One of the more common uses for LCR is to use this feature to automatically insert the long distance access code for long distance calls within your own area code. This will allow these calls to be processed by the selected long distance carrier instead of the local telephone company. The following example is based on an area where all long distance calls must be preceded by 1 + area code as this is the most common scenario.

In MMC 710, program the following entries:

MMC 710		LCR DIGIT TABLE	
INDEX	LCR DIGIT STRING	LENGTH	ROUTE
001	1	11	1
002	2	7	1
003	3	7	1
004	4	7	1
005	5	7	1
006	6	7	1
007	7	7	1
008	8	7	1
009	9	7	1
010	411	3	1
011	911	3	1
012	0	1	1
013	1AAA	11	2

NOTE: AAA is your home area code.

In MMC 711, program the following entries:

MMC 711									LCR TIME TABLE								
TIME CHANGE BANDS																	
	A				B				C				D				
	HHMM	LCRT	HHMM	LCRT	HHMM	LCRT	HHMM	LCRT	HHMM	LCRT	HHMM	LCRT	HHMM	LCRT			
DAY																	
SUN	0001	1															
MON	0001	1															
TUE	0001	1															
WED	0001	1															
THU	0001	1															
FRI	0001	1															
SAT	0001	1															

In MMC 712, program the following entries:

MMC 712					LCR ROUTE TABLE				
LCR ROUTE	TIME CHANGE	LCRCOS	TRK GROUP	MOD DIGITS					
1	1	1	800						
2	1	1	800	001					

In MMC 713, program the following:

MMC 713		LCR MODIFY DIGIT TABLE	
INDEX	NO. OF DELETE DIGITS (15)	NO. OF INSERT DIGITS (14)	NO. OF APPEND DIGITS (14)
001		1010XXX	

NOTE: 1010XXX is the access code for the long distance carrier of your choice.

- [In MMC 603](#), move all of the C.O. lines from trunk group 9 to trunk group 800. You will have to delete the line numbers from trunk group 9 as trunks can be in more than one group.
- [In MMC 724](#), assign 9 as the LCR access code. This will delete 9 from the first trunk group automatically.
- [In MMC 210](#), turn on LCR.

Setting LCR up like this will not prevent C.O. lines from being accessed by Direct Trunk (DT) keys but it does mean that speed dial numbers will have to be reprogrammed to allow them to access LCR.

2.4 USING LCR WITH CALLER ID

It is necessary to have LCR programmed on systems with Caller ID to enable certain features with a DIAL/REDIAL option to be used. This is because the 10 digit CID number format provided by the Central Office always contains the area code. This area code must be stripped off in the LCR modified digits section to allow a local number to be correctly dialed. To make this task easier, the system inserts a 1 in front of the received digits. This makes it look like a normal 11 digit telephone number so LCR can process the number and modify the digits.

For example, if the system is located in the 305 area code, the LCR digit table points the entry 1305 to a modified digits entry that deletes the first four digits of the CID number. Of course, this is a much simplified LCR scheme. As there are long distance calls to be made within the home area code, additional entries are required to identify these calls. This is illustrated in the sample table for MMC 710 below where entries 013 to XXX are the local area code (305 in the previous example) followed by the local CO prefixes. This will tell the system which calls need to have the first four digits stripped off using the modify digits table.

In MMC 710, program the following entries:

MMC 710		LCR DIGIT TABLE	
INDEX	LCR DIGIT STRING	LENGTH	ROUTE
001	1	11	1
002	2	7	1
003	3	7	1
004	4	7	1
005	5	7	1
006	6	7	1
007	7	7	1
008	8	7	1
009	9	7	1

MMC 710		LCR DIGIT TABLE	
010	411	3	1
011	911	3	1
012	0	1	1
013	1AAALLL	11	2
↓	↓	11	2
XXX	1AAALLL	11	2

NOTE: AAA is your home area code and LLL is a local prefix. For example, at STA, AAA= 305 and one LLL = 426. To operate correctly, all of the local prefixes must be entered in this table. These prefixes can be found at the front of the local telephone directory.

In MMC 711, program the following entries:

MMC 711		LCR TIME TABLE						
TIME CHANGE BANDS								
	A		B		C		D	
	HHMM	LCRT	HHMM	LCRT	HHMM	LCRT	HHMM	LCRT
DAY								
SUN	0001	1						
MON	0001	1						
TUE	0001	1						
WED	0001	1						
THU	0001	1						
FRI	0001	1						
SAT	0001	1						

In MMC 712, program the following entries:

MMC 712		LCR ROUTE TABLE		
LCR ROUTE	TIME CHANGE	LCRCOS	TRK GROUP	MOD DIGITS
1	1	1	800	
2	1	1	800	001

In MMC 713, program the following:

MMC 713		LCR MODIFY DIGIT TABLE		
INDEX	NO. OF DELETE DIGITS (15)	NO. OF INSERT DIGITS (14)	NO. OF APPEND DIGITS (14)	
001	4			

NOTE: The deleted digits are the 1 + AAA from the LCR digit table in MMC 710.

- [In MMC 603](#), move all of the C.O. lines from trunk group 9 to trunk group 800. You will have to delete the line numbers from trunk group 9 as trunks can be in more than one group.
- [In MMC 724](#), assign 9 as the LCR access code. This will delete 9 from the first trunk group automatically.
- [In MMC 210](#), turn on LCR.

Setting LCR up like this will not prevent C.O. lines being accessed by Direct Trunk (DT) keys but it does mean that speed dial numbers will have to be reprogrammed to allow them to access LCR.

2.5 UNIFORM CALL DISTRIBUTION

UCD is used to distribute calls to a group of agents. If the group members (agents) are all busy, UCD controls queue patterns and information messages. Callers are held in queue for an available agent. First and second announcements reassure the caller until an agent becomes free. UCD announcements are provided by the Samsung Voicemail system.

The following step by step example demonstrated how to create an UCD application.

A SAMPLE UCD APPLICATION (STEP BY STEP)

1. In [MMC 601](#) create a group of type VMSUCD and place the voicemail ports in it as members. In this example we call this group 505. The ring type should be distributed. Do not use the overflow, GRP TRANSFER or NEXT.
2. In [MMC 601](#), create a group (we use 525) defined as an UCD group and containing the station numbers for the UCD agents. Set the group options as follows:
 - a. Set the ring type to DISTRIBUTED.
 - b. Set the overflow to ten seconds (creates a ten second ringback "grace period" in case all agents are busy before the call overflows to the UCD module).
 - c. Set NEXT to 505.
 - d. Set the wrapup timer. This is an optional timer to allow UCD agents to finish the work associated with a call before receiving the next call.
3. Decide what C.O. lines are to go to the UCD group and assign them to ring 525 in [MMC 406](#).
4. In [MMC 607](#), program the UCD options. These consist of the following:

Message 1: After the caller has overflowed from the UCD group, the first message will immediately play. The default value of '5061' plays a default recording of "I'm sorry, all stations are presently busy". This message number can be assigned from a valid range of 0001 to 9999 (corresponding to voicemail prompts). Please refer to voicemail documentation for customizing prompt recording instructions.

Message 2: If no agent has become free after the UCD recall time, the caller will be played the Message 2. The default value of '5062' plays a default recording of "I'm sorry, all stations are still busy". This message number can be assigned from a valid range of 0001 to 9999. Please refer to Part 4 or Part 6 of the manual for customizing prompt recording instructions. This message will repeat at the UCD recall interval.

Exit Code: This is an option that allows the caller to exit UCD by dialing this digit.

Retry Count: This is the maximum number of times that a caller will be recalled to the UCD message before being transferred to the final destination.

Final Destination: The destination the caller will reach if the exit digit is dialed or the retry count is exceeded.

Ring Next: This timer determines how long an unanswered call will ring a UCD agent before that station is logged out and the next station in the UCD group rings.

UCD Recall: This timer determines the interval between UCD messages played to the caller.

MOH: This determines the MOH source that the caller will be connected to while the UCD recall timer is running.

AUTO LOG OUT: Determines if the ringing station will be logged out if the ring next timer expires.

ALL OUT→FINAL: Determines if calls will go directly to final destination if all agents are logged out.

AGENT PIN NUMBER: Agents have to enter a PIN to log into the group.

GBUSY NEXT: If all agents are busy go directly to next destination.

You have now completed the UCD programming.

2.6 OfficeServ 7100 Voice over IP (VoIP)

Introduction

This OfficeServ 7100 Technical Manual Special Applications section is intended to introduce qualified personnel to the following OfficeServ 7100 VoIP features:

- Supporting the VoIP trunking gateway.
- Supporting Samsung proprietary IP keyset. OfficeServ 7100 can support up to 32 IP stations, which can be combination of any of the following: ITP 5100 Series or Softphone.
- IP Networking: OfficeServ 7100 has the ability to network up to 99 systems together with a high level of feature integration. The networked systems may be any combination of OfficeServ 100, OfficeServ 500, OfficeServ 7100, OfficeServ 7200 and OfficeServ 7400 systems. The OfficeServ 100, 500, and 7200 main software must be at version 2.69 or higher. The OfficeServ 7100 main software must be at version 3.34 or higher.

This document assumes that the user is knowledgeable in TCP/IP concepts and IP network configuration. The procedures involved in building or setting up IP network connectivity is beyond the scope of this document. See your data network administrator for details.

Overview

The MGI VoIP (Media Gateway Interface) series card is a standard and proprietary based Voice over Internet Protocol option card that provides toll quality voice and seamless integration with the OfficeServ 7100 systems via an IP network. The OfficeServ 7100 can support the MGI-16 card. However, the OfficeServ 7100's MP10/MP10a processor card comes with 8 MGI channels intergrated on board. These channels can be activated by the appropriate license key. The MGI also supports Samsung's proprietary ITP 5100 series IP keyphone, Wireless Handset, and Softphone. MGI converts voice and signaling into IP packets, which can be transmitted over any TCP/IP network so that voice looks like data. VoIP provides the solution for desktop accessibility in the enterprise business environment. The easy addition of MGI boards in the OfficeServ 7100 systems requires no integration into a server or desktop personal computer. VoIP calls can be established from desktop telephone instruments without complex integration of software or hardware. VoIP eliminates the cost of maintaining separate networks for voice communications in the Intranet environment.

VoIP Overview

VoIP is transported by the OfficeServ 7100 MGI utilizing the standards based Internet Protocol. This standard addresses the means of transferring voice, data, and images through IP (Internet Protocol) networks. IP is the accepted protocol standard for transporting data. With VoIP certain compression standards have also been adopted to represent each second of voice with an amount of bandwidth. The OfficeServ 7100 MGI can utilize G.711, G.729A, G.729 or G.723 standards voice compression codec's (card dependant). This allows for a selectable 64kbps, 8Kbps or 6.3Kbps bandwidth use when preparing voice compression for IP transport on a particular network. Compression is used to reduce the digitized voice into a smaller bandwidth that can be carried in smaller packets. The MGI can determine the compression method for each individual call setup. There is also a certain amount of frame/packet overhead in each compression channel. 64Kbps of bandwidth can support 4~5 calls simultaneously. This can vary depending on efficiency features like codec selection, Silence Suppression and Multiframe counts. Unlike switched networks, VoIP connections use the packet switching method and consist of a sequence of numbered of data packets. Since voice conversation is usually considered "real time" these packets need to be delivered in a consistent manner with minimal delay.

In any IP network environment, packet transfers are subject to delays and/or loss. If these delays are great, the voice quality will deteriorate severely. The Ethernet data traffic and network topology should be a consideration when applying VoIP transport. Network congestion does affect call quality in any VoIP application.

ITP 5100 Series Keyphone Overview

The Samsung ITP 5100 series IP keyphones provide full iDCS keyphone functionality locally or remotely on an IP network. The unique ITP keyphone instruments communicate with the OfficeServ 7100 system in a proprietary IP message format to emulate full keyphone functionality. Working in conjunction with the MP10/MP10a and the MGI, the ITP keyphone can access all station features and trunk facilities on the OfficeServ 7100 system. The ITP keyphone can function on private networks (Intranet) or public IP networks (Internet). ITP keyphones support DHCP services and can also function behind **NAT (Network Address Translation)** routers. All of the ITP models support PoE (Power Over Ethernet, IEEE 802.3af). This means that they can be powered by any PoE LAN switch instead of the AC adapter. Of course they can still be powered by the AC adapter connection to an AC outlet. There are three types of ITP 5100 series keyphones:

- **ITP-5121D and ITP-5107S**

The **ITP-5121D** and **ITP-5107S** have 21 and 7 programmable buttons respectively and full traditional iDCS keyset functionality. The LCD display is a 2 line 16 character display that informs the user as to call status and call states. The LCD also indicates incoming call parameters. Traditional features such as Station Camp-on, Station Paging, Offhook Voice Announce are seamless with the ITP series keyphones. Other traditional buttons such as Transfer, Hold, Speaker, Volume control, Redial, Conference and the Samsung intuitive Softkeys make them truly functional. In addition to the standard keyphone keys there is a navigation button that allows scrolling through various keyphone menu parameters (navigation key is not available on 5107S model). [See the ITP 5100 Series Keyphone User Guides for more details.](#)

Figure 1. ITP-5121D Keyphone and ITP-5107S Keyphone



- **ITP-5112L**

The **ITP-5112L** is a large LCD color display ITP keyphone. The large display features interactive softkeys to navigate through system keyphone features. The large display supports a visual status bar, title bar, Icons associated with 12 selection buttons and call aid graphics. The LCD also indicates incoming call parameters via Icons. Other traditional buttons such as Transfer, Hold, Speaker, Volume control, Redial, Conference make the ITP-5112L truly functional. Up to 99 buttons can be programmed on the ITP-5112L. In addition to the standard keyphone keys the navigation button also allows scrolling through various keyphone menu parameters. [See the ITP 5100 Series Keyphone User Guides for more details.](#)

Figure 2. ITP-5112L Keyphone



NOTE:

The OfficeServ 7100 supports two forms of MGI's:

1. On-board 8-channel MGI that is integrated on the MP10/MP10a card. This form of the MGI shares the same IP configuration and physical LAN connection as the MP10/MP10a. The on-board channels are activated by license key.
2. MGI-16 card can be installed in either of the two universal slots. This card offers 16 channels and must be assigned its own unique IP configuration and has its own LAN connection.

MGI Hardware Overview

The MGI (Media Gateway Interface) card supports a diverse range of features and applications. The selectable features are H.323 VoIP trunking, SIP VoIP trunking, OfficeServ 7100 System Networking via IP and the Samsung ITP 5100 series keyphones. MGI cards support these features on a per port basis. Each MGI card has an embedded RJ 45 10/100 BaseT Ethernet female connector on the face of each card which allows a standard RJ45 UTP data cable connection for IP network connections. LEDs on the front of the card provide operational status. The MGI cards automatically detect 100BaseT Ethernet networks. There are no selectable options on the MGI cards. The on-board MGI of the 7100 shares the MP-10's RJ-45 connector.

The on board MGI and the MGI-16 support the following services and features:

- IP Phones
- IP Networking (Network multiple systems over an IP Network)
- G729 CODEC, G.723.1, G.711, G.729A CODECs
- SIP and H.323 IP Trunking
- T.38 Fax CODEC
- Out-of-band signaling of DTMF tones
- QoS (ToS/DiffServ)
- VLAN (802.1 p/q)

MGI Card Installation

If you are using the on-board MGI channels, then log into system programming and enter MMC 841. Select the "MP MGI/VM KEY" option and enter the appropriate license key to activate the MGI channels.

The MGI-16 card can mount in any OfficeServ 7100 universal card slot. Add as many as needed. You are only limited by the number of available slots.

There is a processor on the MGI-16 cards so it is not recommended to insert this card with system power on. [Refer to the OfficeServ 7100 Installation manual for further details on MGI card installation.](#) The MGI-16 card does not require a license key to be activated.

Card Insertion

Power OFF the OfficeServ 7100 system. Insert the required quantity of MGI cards into the appropriate card slots. Push firmly in the middle of both card ejectors on each card to ensure that it is fully inserted into the backplane connector. Connect IP network cable(s). Power ON the OfficeServ 7100 system.

MGI IP Network Connection Cable

The cable needed to connect the MGI-16 to an IP network is a standard “straight” 8 conductor data cable. This cable is sometimes referred to as a LAN UTP Category 5, 4 pair RJ45 male to male data patch cable. Connection to the network can be via a patch panel or data hub type device. The data patch cable is not provided with the MGI card and must be purchased separately through a data equipment supplier.

NOTE: The Ethernet network cables on the MGI-16 and MP10/MP10a cards MUST be connected to the data network upon power up to detect the Ethernet connection. The MGI or MP10/MP10a cards CAN be connected after power up but must be reset to detect the network connection.

If you are using the on-board MGI channels, then you only need to connect one LAN cable to the MP10/MP10a LAN port.

MGI Operation Overview

The MGI cards have the voice CODEC's for VoIP and an RJ45 10/100 10BaseT connector for the network connection(s). The MGI handles the voice to data and data to voice conversion while the MP10/MP10a handles call signaling and setup/tear down, CODEC selection, availability, CODEC usage type etc. The MP10/MP10a also has an RJ45 10/100 BaseT connector. BOTH the MGI and MP10/MP10a cards must be connected to the same network together. This is required to reduce delay of information if traversing routers and other data network equipment. Of course if you are using the on-board MGI channels, the MP10/MP10a and the on-board MGI share the same IP address and LAN connection since the MP10/MP10a also performs the MGI function.

Unique programming allows the access to the private Intranet and Public Internet services simultaneously. This is accomplished via programming static IP addresses for specific uses.

The MGI use is distributed via channels. Port reference is used to accommodate a more static perception of the MGI channel identity. For simplicity the word port will be used to reference MGI card channels.

The MGI can be used for several functions simultaneously or individually. Each MGI port will auto negotiate the service of each port for the type of usage required. This means that the same port can use SIP trunking for one call and H.323 for the next call without any programming changes. With multiple MGI cards installed, service grading of the MGI can be programmed so that specific MGI channels can be selected for different uses. This grading is similar to standard trunk grading where the number of users do not match the number of available lines. If a one to one ratio is required for total non-blocking service this can be accomplished via programming and selection of the number of simultaneous uses in proportion to the number of MGI ports.

MGI card(s) use of services can also be shared. MMC 615: MGI Group, allows the segregation of services to specific cards. MMC 724: Dial Numbering Plan, allows addressing of the default numbers and trunk assignments to customize the application. MMC 831: MGI Parameters provides the MGI card(s) with IP address information. [The MGI Services will be explained in detail in the MGI Functional Overview section found later on in this Application Section.](#)

MGI Services:

- H.323 Trunking Gateway
- SIP Trunking Gateway
- ITP keyphone CODEC support
- VoIP Networking (SPNet)

MP10/MP10a

The MP10/MP10a provides a robust IP platform on the OfficeServ 7100. The MP10/MP10a supports the default LAN connection via the RJ 45 10/100 BaseT port on the face of the card. This connects to the same IP network that the MGI card(s) are connected to. (ITP keyphones can be on the same or a different network). The OfficeServ 7100 system IP address is registered on the MP10/MP10a card. All IP connectivity is directed to the MP10/MP10a IP address. MMC 830: Ethernet Parameters, provides the selections for the system MP10/MP10a IP address.

MGI Card Relationships

Theory of Operation

When an IP call is directed to the OfficeServ 7100 system the MP10/MP10a performs the call control and setup to the remote calling or called IP endpoint.

Once the MP10/MP10a negotiates the setup a determination is made if the IP call is intended to be received by another IP device on the IP side or a TDM port on the circuit switched side of the OfficeServ 7100. When the request is for a circuit switched side connection, the MP10/MP10a controls the MGI and sets up a channel for the IP call to use a codec on the MGI as a gateway to the circuit switched environment. The MGI supports the voice codec to the

trunks or stations inside the OfficeServ 7100 system. All other controls are managed by the MP10/MP10a. i.e. Setup, teardown, LED status updates in the case of the ITP series keyphones.

The same theory of operation applies on an incoming IP call. The called IP address is the MP10/MP10a card. The MP10/MP10a informs the calling IP party that the voice portion of the call will be managed by the MGI. See Figure 3.

Figure 3. MGI and MP10/MP10a LAN Relationship

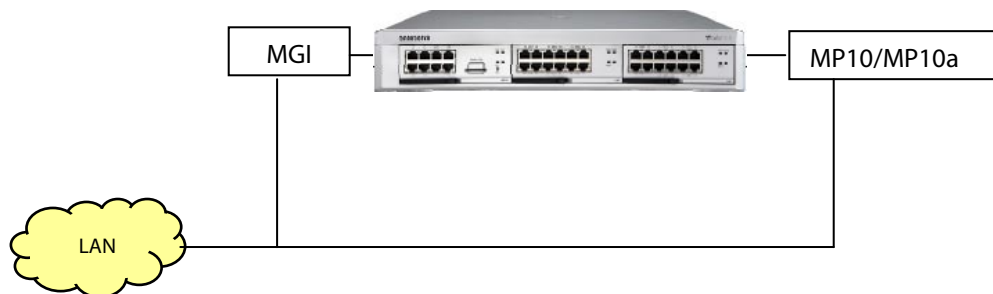

ITP Keyphone, MGI and MP10/MP10a Relationships

ITP Keyphone and iDCS Keyphone Operation

The ITP 5100 series keyphones use the MGI as the voice gateway when connected to the OfficeServ 7100 system stations or trunks. The MP10/MP10a is involved to provide call setup and tear down, programmable button functions, displays and system feature access.

ITP 5100 series keyphones provide Auto Codec Negotiation and follows the VoIP codec settings of the MGI card(s) used. There can be more ITP keyphones than available MGI channels. This is due to voice traffic possibilities. If it is not anticipated that all ITP keyphones will be in use at the same time the probability factor of not having a voice channel can be calculated based on the station activity or use. If an ITP keyphone attempts to use an MGI card that does not have a voice channel available, the ITP keyphone display will show "No MGI Channels Available"

The ITP 5100 series keyphones must be programmed to provide the keyphone IP address, subnet mask, router gateway (if used) and MP10/MP10a (IP Server) address. Each ITP keyphone must also have a User ID and Password. This User ID and Password must match the User ID and Password in the OfficeServ 7100 system (MMC 840: IP SET INFO). The ID and Password are used to register the ITP keyphone to the OfficeServ 7100 and retain the number associated with that particular ITP keyphone. The ITP keyphones will register with the MP10/MP10a and be provided a default extension number from the OfficeServ 7100 system provided the ID and password match. The assigned default numbers can easily be changed to

match the iDCS keyphone station numbering plan. New ITP keyphone registrations can be enabled or disabled via MMC 840 and MMC 841: IP SET INFO, SYS IP OPTN. See Figure 4 for the relationship of ITP keyphone and iDCS keyphones.

Figure 4. Connectivity of a call between an ITP Keyphone and iDCS Keyphone:

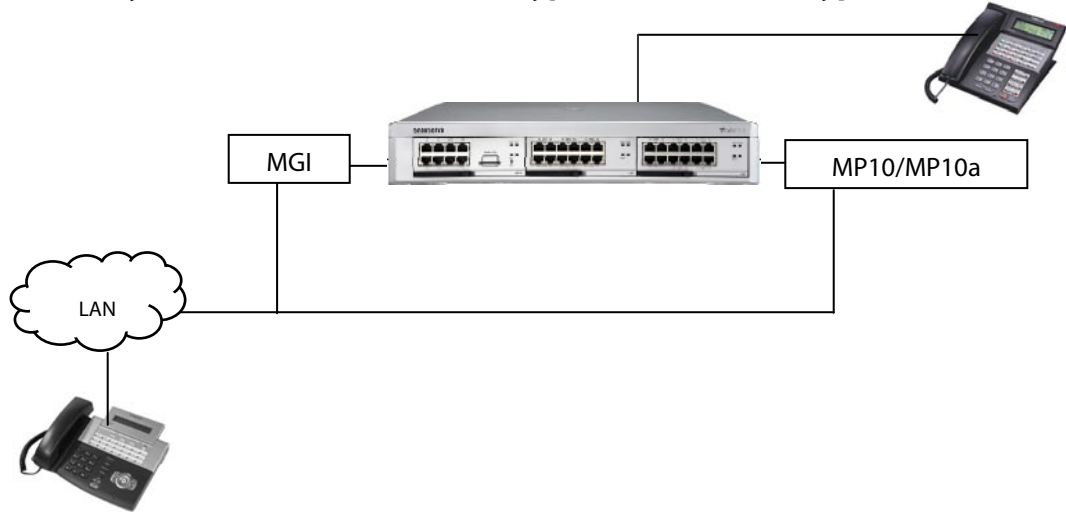

ITP Keyphone to ITP Keyphone Operation

When an ITP keyphone is connected and in conversation to another ITP keyphone the MGI card audio codec is not involved when called on the private network side. The MP10/MP10a is involved to provide call setup and tear down, programmable button functions, displays and system feature accesses. However, an MGI port is used for system features such as conference and transfer or internal paging as needed. See Figure 5.

Figure 5. Connectivity between ITP Keyphones:

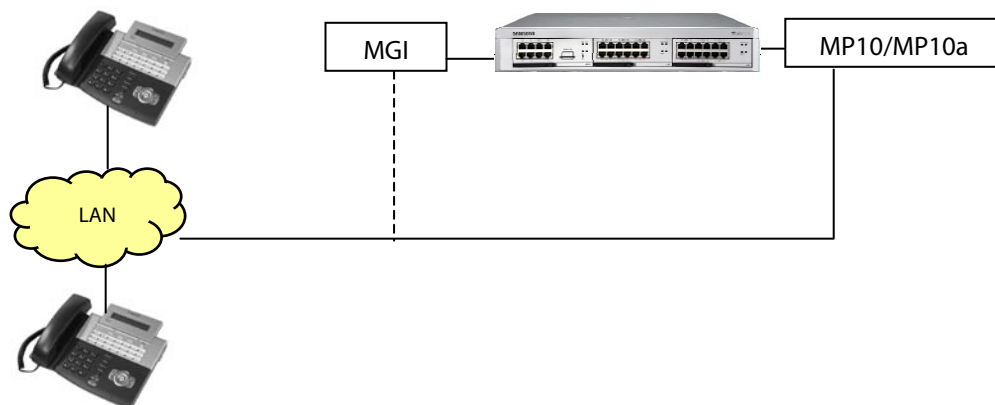

Remote ITP Keyphones

The ITP 5100 series key phones are unique in the fact that they function beyond the confines of the existing LAN and will work normally on a WAN (Wide Area Network) infrastructure and traverse routers and switches when connected remotely. The ITP keyphone simply needs to know the MP10/MP10a server IP address and have the matching ID and Password. The ITP Server is the address of the MP10/MP10a OfficeServ 7100 system supporting that ITP keyphone. The ID and Password are used to register the ITP keyphone to the OfficeServ 7100 and retain that number associated with the registered ITP keyphone. The data infrastructure (IE routers and switched hubs) allows connectivity via IP between the ITP keyphone and the MP10/MP10a. Note that in Figure 6 that ITP 1 is on a different network than ITP 2. [Public IP and Private IP relationships will be covered further on in this Special Application Guide.](#) See Figure 6.

Figure 6. Remote ITP Keyset (shown with iDCS keyphone connectivity also)

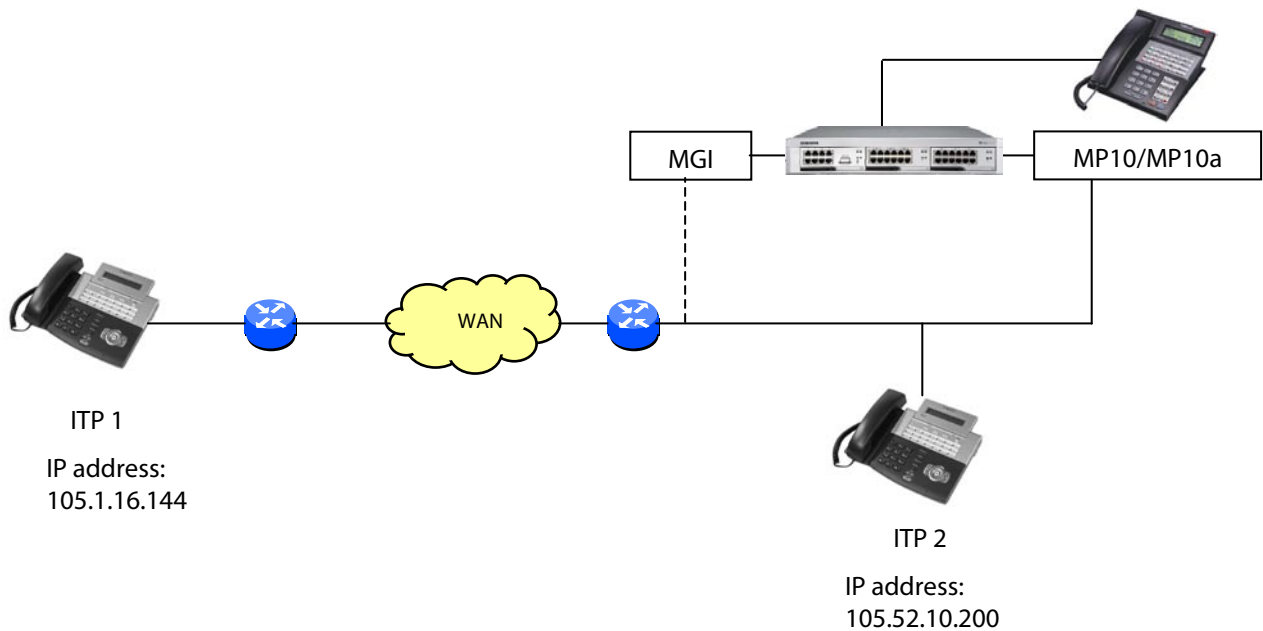

OfficeServ 7100 MGI Functional Overview

MGI Operational Concepts

The MGI supports several VoIP services. In supporting multiple services the MGI ports are capable of using different protocols (IE Proprietary, SIP or H.323) automatically on a per port basis as needed. This allows the mixing of different standards on the same MGI card(s).

In certain applications there may be a need to separate or segregate the card(s) for specific uses. An example of this is where there are two MGI cards mounted and one card is used exclusively as a VoIP trunk gateway and the second card is used to support ITP keyphones. In this case each card can be defined as to what service it will provide. IE. VoIP trunking gateway use or ITP keyphone use. In another case, where the MGI has 16 VoIP channels, it is possible to segregate or partition some of these channels for ITP keyphones and use the remaining channels for trunking gateway use on the same card.

In order to understand the task of segregating MGI cards for traffic or grading purposes the following is a brief description of the multiple uses of an MGI card. MMC 615: MGI Group allows separation of these services. By default all MGI ports are available for all services.

MGI Services

Each of the MGI services provide for private network and public network exposure. This allows connectivity to the public Internet without exposing the private network. This allows router traversal by remote ITP keysets and far end gateway services and systems. [Public network and Private network relationships will be reviewed further on in this Special Applications section.](#)

H.323 Trunking Gateway

The MGI card(s) when used as a VoIP trunking gateway allows VoIP call connectivity to opposite MGI's, or other H.323 standards based VoIP gateways. Calls placed in this mode are treated like IP tie line trunk calls. As a tie line type trunk, incoming digits are expected. Programming allows routing of incoming calls based on incoming digits, digit translation or trunk ring destinations. Outgoing calls are made by selecting the trunk or trunk group and dialing the appropriate digits to reach a predetermined destination. The flexible programming allows outgoing digit manipulation with LCR like routing.

SIP Trunking Gateway

The MGI card(s) when used as a SIP (Session Initiation Protocol) trunking gateway allows VoIP call connectivity to opposite MGI's, or other SIP standards based VoIP gateways or devices. Calls placed in this mode are treated like IP tie line trunk calls. As a tie line type trunk, incoming digits are expected. Programming allows routing of incoming calls based on incoming digits, digit translation or trunk ring destinations. Outgoing calls are made by

selecting the trunk or trunk group and dialing the appropriate digits to reach a predetermined destination. The flexible programming allows outgoing digit manipulation with LCR like routing.

SIP trunking gateway programming follows the same programming as the H.323 programming but has an additional MMC to address the SIP attributes. MMC 837: SIP Options, includes general SIP inquiries, response times, UDP ports, SIP server addresses and other related SIP options.

ITP Keyphone Support

The ITP keyphones use the CODEC's on the MGI when calling a circuit switched digital keyphone or an outside trunk in the OfficeServ 7100 system. The MP10/MP10a controls the setup messages and determines if the destination (IE iDCS keyphones or outside trunks) require the use of the MGI. The ITP keyphones only use the MGI when accessing the OfficeServ 7100 circuit switched system side. ITP to ITP calls do not use the MGI when called on a private network. This aspect of use can determine how many MGI cards need to be installed based on ITP station traffic considerations. The number of ITP keyphones does not need to match the number of MGI channels unless a complete non-blocking application is required.

VoIP Networking Gateway

The MGI supports the voice when connections between OfficeServ systems are set up to use the IP Networking Feature. IP Networking Features are the same as the PRI Networking features but use IP as the transport method. Point to point calls are originated and terminated as VoIP trunks but the informational data is exchanged via IP packets between MP10/MP10a cards.

Facsimile over IP

This option assigns the number of ports used to support IP facsimiles. The MGI card supports the T.38 facsimile over IP standard.

Each MGI-16 can support a maximum of 2 simultaneous fax calls. The same applies to the on-board MGI.

MGI Group Numbering Plan

When using MMC 615: MGI Group, an understanding of the multi-use aspect of the MGI should be understood. There is a correlation between the Numbering Plan and Trunk Group Members. To provide a perspective of the port assignment on the MGI card(s) Table 1 should be used as an example to understand default assignments. For brevity the first 8 port assignments are shown in the example.

MMC 615: MGI Group Assignments, selects which MGI ports will be accessed based on the call type. Default assignments allow all ports to connect to all services.

Local ITP: This refers to ITP keyphone stations on a private network.

Public IP ITP: This selects ports to be used by ITP keyphone by the public or exposed side of the network.

VoIP Network: This refers to ports used when using the iDCS Networking features on a private network. These ports will transport the voice side of an OfficeServ 7100 system networking call.

Public IP Network: This selects ports that will be used when using the iDCS Networking features via a public or exposed IP networking. These ports will transport the voice side of an OfficeServ 7100 system networking call.

VoIP Trunk: This refers to the MGI ports that will be used for VoIP trunking gateway calls on a private network.

Public VoIP Trunk: This refers to the MGI ports that will be used for VoIP trunking gateway calls via a public or exposed network.

Table 1: MGI Group default Numbering Plan Assignments:

MGI PORT/ MEMBER	MGI NUMBER PLAN	LOCAL ITP GROUP MEMBER MMC 615	PUBLIC ITP GROUP MEMBER MMC 615	ITP STATION NUMBER PLAN IDX MMC 724	IP NETWORK GROUP MEMBER MMC 615	PUBLIC IP NETWORK GROUP MEMBER MMC 615	VOIP NETWORK NUMBER PLAN MMC 724	VOIP TRUNK MEMBER MMC 615	PUBLIC VOIP TRUNK MEMBER MMC 615	VOIP TRUNK NUMBER PLAN MMC 724	VOIP SIP TRUNK NUMBER PLAN MMC 724
3801	3801	3801	3801	3201	3801	3801	8301	3801	3801	8401	8501
3802	3802	3802	3802	3202	3802	3802	8302	3802	3802	8402	8502
3803	3803	3803	3803	3203	3803	3803	8303	3803	3803	8403	8503
3804	3804	3804	3804	3204	3804	3804	8304	3804	3804	8404	8504
3805	3805	3805	3805	3205	3805	3805	8305	3805	3805	8405	8505
3806	3806	3806	3806	3206	3806	3806	8306	3806	3806	8406	8506
3807	3807	3807	3807	3207	3807	3807	8307	3807	3807	8407	8507
3808	3808	3808	3808	3208	3808	3808	8308	3808	3808	8408	8508

*SIP trunks are VoIP Trunk members in MMC 615: MGI Group.

For traffic considerations, (IE CODEC availability at any given time) specific ports may be selected to be accessed for defined uses. In the Table 2 example the eight port MGI card will be segregated to allow the first four ports to be used for ITP keyphones and the last four ports as VoIP trunking gateway ports all on a private network. The other services are not used so they are removed for clarity.

Table 2: MGI programmed assignments

MGI PORT/ MEMBER	MGI NUMBER PLAN	LOCAL ITP GROUP MEMBER MMC 615	PUBLIC ITP GROUP MEMBER MMC 615	ITP STATION NUMBER PLAN IDX MMC 724	VOIP NETWORK GROUP MEMBER MMC 615	PUBLIC IP NETWORK GROUP MEMBER MMC 615	VOIP NETWORK NUMBER PLAN IDX MMC 724	VOIP TRUNK MEMBER MMC 615	PUBLIC VOIP TRUNK MEMBER MMC 615	VOIP TRUNK NUMBER PLAN IDX MMC 724	SIP TRUNK NUMBER PLAN IDX MMC 724
3801	3801	3801		3201							
3802	3802	3802		3202							
3803	3803	3803		3203							
3804	3804	3804		3204							
3805	3805			3205				3805		8405	
3806	3806			3206				3806		8406	
3807	3807			3207				3807		8407	
3808	3808			3208				3808		8408	

*SIP trunks are VoIP Trunk members in MMC 615: MGI Group.

In the above numbering plan example there is a one to one relationship of available MGI ports and ITP keyphones.

Further refinement to the numbering plan assignments can be made by adding the VoIP trunks to a specific trunk group. (IE. 802, 803 etc.)

H.323 or SIP Trunking Gateway

The OfficeServ 7100 MGI functions as a VoIP trunking gateway. The OfficeServ 7100 software considers the MGI ports as trunk ports. As a trunking gateway the MGI card support the H.323 or SIP standards on a per port basis as needed. The OfficeServ 7100 MGI card programming is similar to installing or adding other cards in the OfficeServ 7100 system. Each MGI card has ports assigned that are comparable to the system trunk ports. In a default system the OfficeServ 7100 will automatically identify that an MGI card is present and assign trunk numbers to the available ports. The trunk numbers will be in the 84XX range. If an MGI card is to be added to an existing system it is recommended to power off the cabinet that the card is going to be installed in.

Programming MGI trunks are similar to programming traditional trunks. The MGI VoIP trunks can be in trunk groups (MMC 603 Assign Trunk Groups) or MGI VoIP trunks can be individually assigned as Direct Trunk Keys (MMC 722, MMC 723 Key Assignments). MGI VoIP trunks can also be included in LCR programming to provide alternative routing of outgoing calls. Station calls between OfficeServ 7100 systems via VoIP can also be accomplished via MGI trunks. An MGI or other compatible VoIP gateway equipment must be present on the LAN or WAN to place VoIP calls to and from the MGI card.

VoIP Trunk Call Routing Concept

VoIP calls via the MGI use routing tables to determine where to route the call based on digits dialed. Digits can be added or removed as part of the call and be transparent to the calling station. The digits dialed then reference a table that has the destination IP address then repeats the digits needed at the far end.

Programming of the MGI follows an LCR type of programming where the tables are used to reference the dialed number and send the call to the right IP destination. It is not necessary to have System feature LCR programmed to use the MGI VoIP facilities. Incoming calls via the MGI can be directed three different ways, Follow the DID Translation table, Follow Incoming Digits or Follow Trunk ring assignments. These settings are system wide and affect all MGI cards used as trunking gateways. The outbound routing tables are referenced by MGI cards system wide.

A basic example of the direct station to station dialing string in an OfficeServ 7100 directing a call over an MGI card to another OfficeServ 7100 MGI card is as follows:

80 0 201

- 80 is the trunk group access code to the MGI trunks.
- 0 is the access code that references an IP address table.
- 201 is a station in the distant OfficeServ 7100 system.

In the above example the station caller will hear a second dial tone when 80 is dialed. After dialing 0 and station number 201 the MGI program looks up the corresponding IP address

with the access code 0. IP communications are established between the MP10/MP10a of the originating system and the far end MP10/MP10a. The access code 0 is deleted then the digits 201 are sent in an IP packet and repeated by the far end MGI. The caller will hear station ringback tone and is able to converse when the called party answers. The access code can also be imbedded in the sent digit string information allowing more transparent dialing.

This concept is used only when using the MGI as a trunking gateway. IP Networking uses the communications between MP10/MP10a cards to determine the MGI use so trunking gateway inputs are not required.

Internet Protocol (IP) Addressing

To program the MGI VoIP it must be known where to route IP based calls. A basic knowledge of Internet Protocol (IP) networking should be understood to program IP addresses and IP gateway addressing. The OfficeServ 7100 must have an IP address associated with the MP10/MP10a and each MGI-16 card installed. This is the same address if using the on-board MGI channels. The MGI cards can be programmed only after installed in the system. The IP address can match the existing LAN (Local Area Network) addressing scheme or it can be a totally different IP address level. It is suggested to match the existing LAN IP address plan to permit ease of administration. Also required will be an IP subnet mask and a gateway address.

Subnet addresses allow connectivity in the same network and determines if the data needs be forwarded to a router.

Gateway is a term used as a junctor or the meeting point of two networks. This meeting point can be a router or an MGI card. When a request is made by a PC or other IP device (MP10/MP10a or MGI) and the address is not in the local network the gateway IP address is where the next search is performed. The gateway then looks outside the local network for a response to the request. This all happens within milliseconds. Once a response is obtained, the LAN gateway router acts as the bridge between the two networks. The information can be strictly data or it can be voice data. In the OfficeServ 7100 MP10/MP10a and MGI, programming the gateway is equivalent to the router address to leave the local LAN and access another network.

ITP Keyphones and IP Network Connectivity

The OfficeServ 7100 MGI cards provide a proprietary gateway between the ITP keyphones and the system features and services. The connections between networks should be understood before requesting or installing the services for local or remote location ITP keyphones.

Public and Private IP Connectivity

The MP10/MP10a, MGI and ITP keyphones can be used on the private Intranet LAN/WAN and also have a public Internet presence. This is accomplished by defining the public address on the MP10/MP10a and MGI cards. ITP keyphones can also be registered as public IP addresses

but still communicate with the private network stations and system. Figure 7 shows the relationship between public and private networks.

In any case with Public network exposure there must be a public address for the MP10/MP10a and each MGI that will connect to the Public network. The remote ITP must have at least one public IP address available. When using a NAT router at the remote ITP end there only needs to be one public IP address.

Figure 7. Public and Private Networks

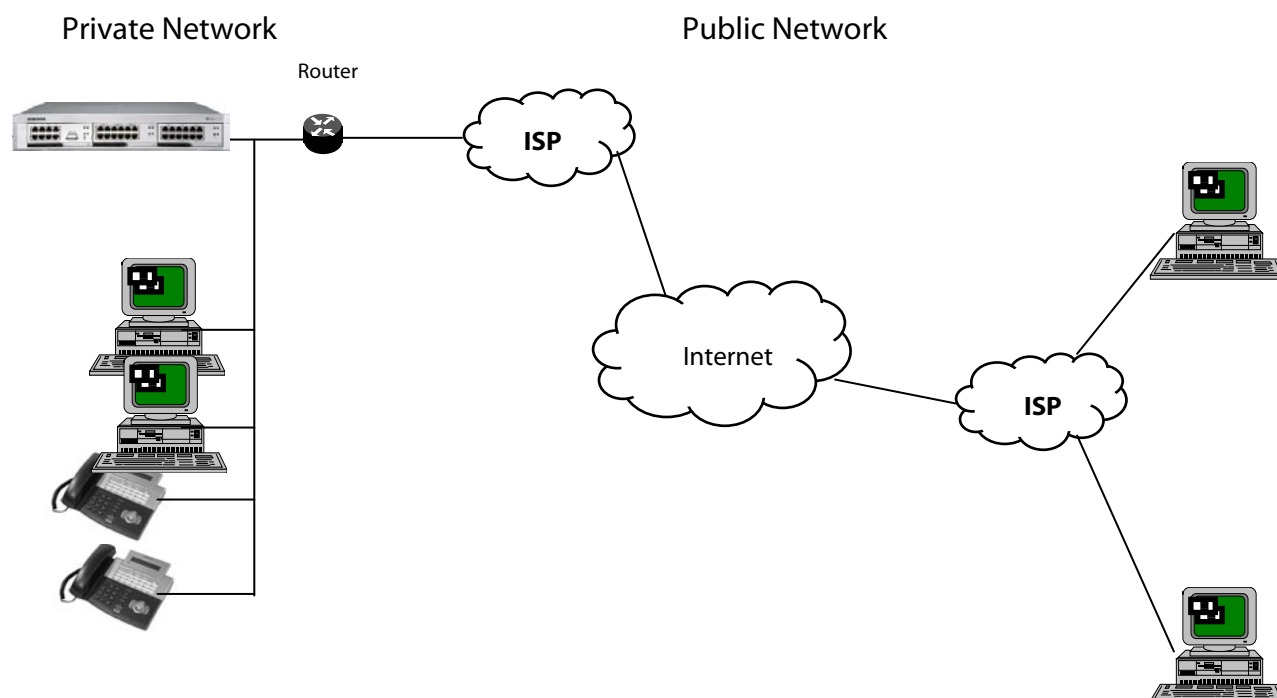

“Public” networks can be defined as a network that is open to the public Internet. Anyone with access to the Internet can access the endpoint(s) via an IP address. This endpoint can be a server, email server, PC or router.

“Private” network is the network that has an IP addressing scheme that is used behind a router to protect the user endpoints from being accessed by the public. In some cases the router has a “NAT” (Network Address Translation) setting. This allows the user(s) behind the NAT router to look as a single address to the public network.

In the OfficeServ 7100 “public” and “private” do not necessarily actually mean public and private. These are relational terms to determine if the MP10/MP10a must look at source IP addresses and convert to a destination address. This is done when there are two different networks. As an example, if all the IP addresses are exposed to the “public” unprotected Internet network. The programming for the MP10/MP10a, MGI, and ITP keyphones would be programmed as private. They are all on the same network.

If the MP10/MP10a, MGI and several ITP keyphones were on a LAN based “private”, protected network, behind a router and the Internet IP address was in front of the router and “exposed” to the public Internet the programming for the MP10/MP10a, MGI and local ITP keyphones would be private. In this case the MP10/MP10a, MGI and remote ITP keyphone would also have public IP entries to show the external Internet addresses for translation to the internal Intranet. This external public entry address allows the MP10/MP10a to convert the external IP address to the internal private addresses.

Customer Provided Routers

Exposure of the private network to the public can compromise the security of the private network. To use the Private with Public relationship the networks are usually separated by a router and/or firewall. The routers used MUST be able to support “reservations” or “port forwarding” feature. The Reservations feature in routers allows the router to “reserve” an internal IP address to be permanently connected or forwarded to an external IP address. This permits packets sent to and from the external IP address to be sent to the internal IP address. Different router manufacturer’s support varying numbers of reservations or port forwarding. Without this feature in the customer supplied router the OfficeServ 7100 Private with Public IP addressing will not function and all address must then be exposed to the public network. A router supporting this feature permits the iDCS VoIP features while also allowing the customer to access the public Internet from their LAN based PC’s (separate IP address required).

In most applications the equipment supporting reservations would be located at the OfficeServ 7100 system side. The remote location can have a either a public static IP address for each ITP keyphone, a NAT supporting router with a single public IP address with multiple ITP keyphones.

Remote ITP Keyphone with Public Static IP Addressing

Figure 8 shows the relationship between the MP10/MP10a, MGI and remote ITP keyphone. With the entire network “exposed” connectivity is permitted but there is no way to put ITP keyphones on a private LAN network without “exposing” the private data network to the public domain. In this topology the programming in the OfficeServ 7100 for the MP10/MP10a, MGI and ITP keyphone can be considered Private because they are all on the same network. This example shows an MGI-16. If it were using the on-board MGI channels, then the MGI card and MP10/MP10a board would share the same IP configuration.

Figure 8. Remote ITP with Public Static IP Addresses

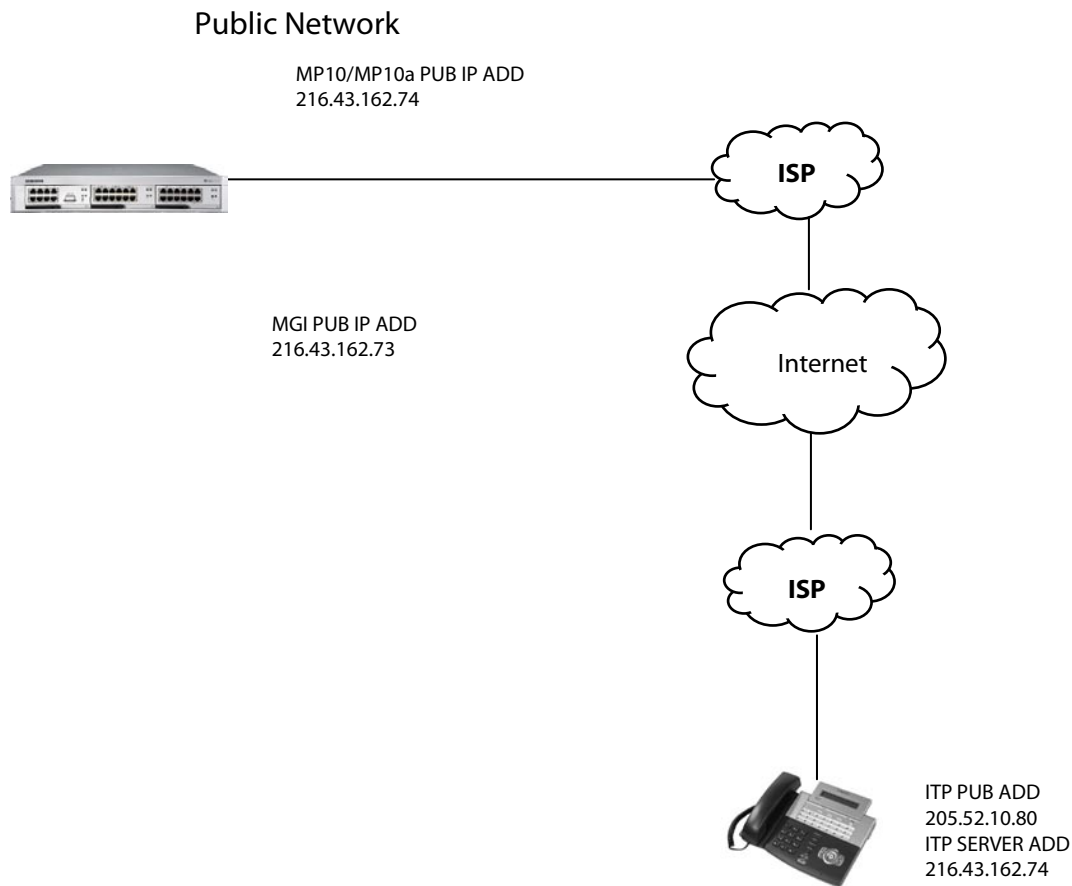

Reservations / Port Forwarding Router Addressing with Static IP Remote ITP Keyphone

Figure 9 shows the relationship between the MP10/MP10a, MGI and a remote ITP keyphone using a router to provide a separation between the Private and Public networks. With the MP10/MP10a on the private network this also permits ITP keyphones to be connected on the private network side and the public network side. Note in Figure 9 that the Server Address in the ITP keyphone is the “exposed” public MP10/MP10a Public IP address. The customer provided router in this case must “reserve” or forward the MP10/MP10a and MGI public IP addresses to the private MP10/MP10a and MGI IP addresses. Note that the remote ITP Server IP address is that of the public MP10/MP10a.

Figure 9. Private Network with Public Network ITP Keyphones

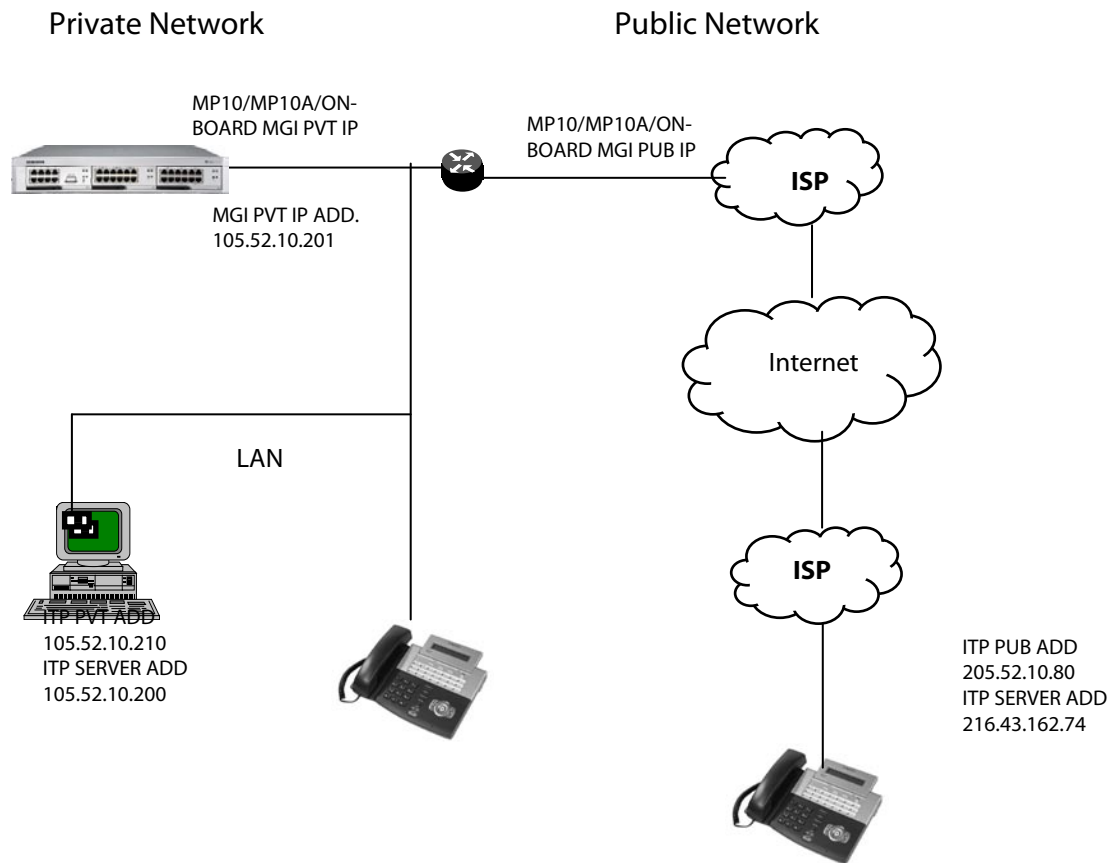

Remote ITP Keyphones with Reservations Router Addressing

Figure 10 shows Private with Public connectivity using router reservations or port forwarding at the OfficeServ 7100 end the remote ITP endpoint(s). In all cases, on a public application, a public IP addresses must be obtained for the MP10/MP10a and the MGI card(s). A public IP address must also be obtained for each remote ITP keyphone that will be addressed when using router reservations and a publicly exposed remote end. Note in this example that both ends (MP10/MP10a, MGI and ITPs) are using port forwarding or reservation to expose the MP10/MP10a, MGI and ITP's to the public network and still allowing a private network that is not exposed.

Figure 10. Private Network with Public ITP Keyphones using Router Reservations

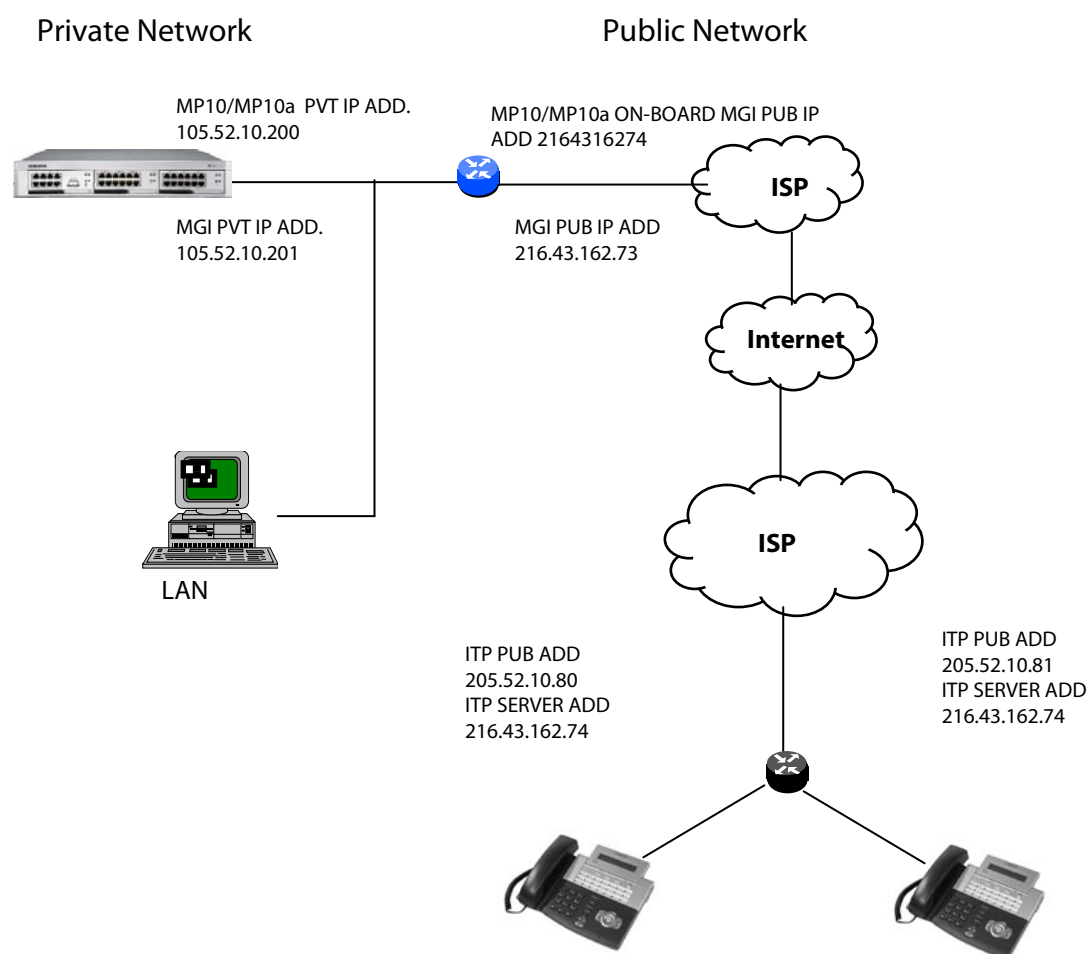

ITP Keyphone with Remote NAT Router Addressing

Figure 11a shows Private with Public connectivity using a router supporting reservations or port forwarding at the OfficeServ 7100 end and a NAT supporting router at the remote ITP endpoint. In public network cases a public IP addresses must be obtained for the MP10/MP10a and the MGI card(s). A static public IP address OR a DHCP address can be obtained for the remote ITP keyphone(s) location(s). The ITP keyphones can also acquire an IP address from the NAT/DHCP router so that they may match the IP addressing scheme of the network where they are located. When using the routers' NAT feature multiple ITP keyphones can register to the MP10/MP10a.

Figure 11b also shows remote ITP keyphones using a NAT router. This approach is extremely cost effective due to the ITP and LAN PC's using the same public address. The ITP's use the public address to reach the OfficeServ 7100 system and the LAN PC's use the public address to access the Internet.

Figure 11a. Private Network with Remote ITP Keyphone NAT Router Addressing

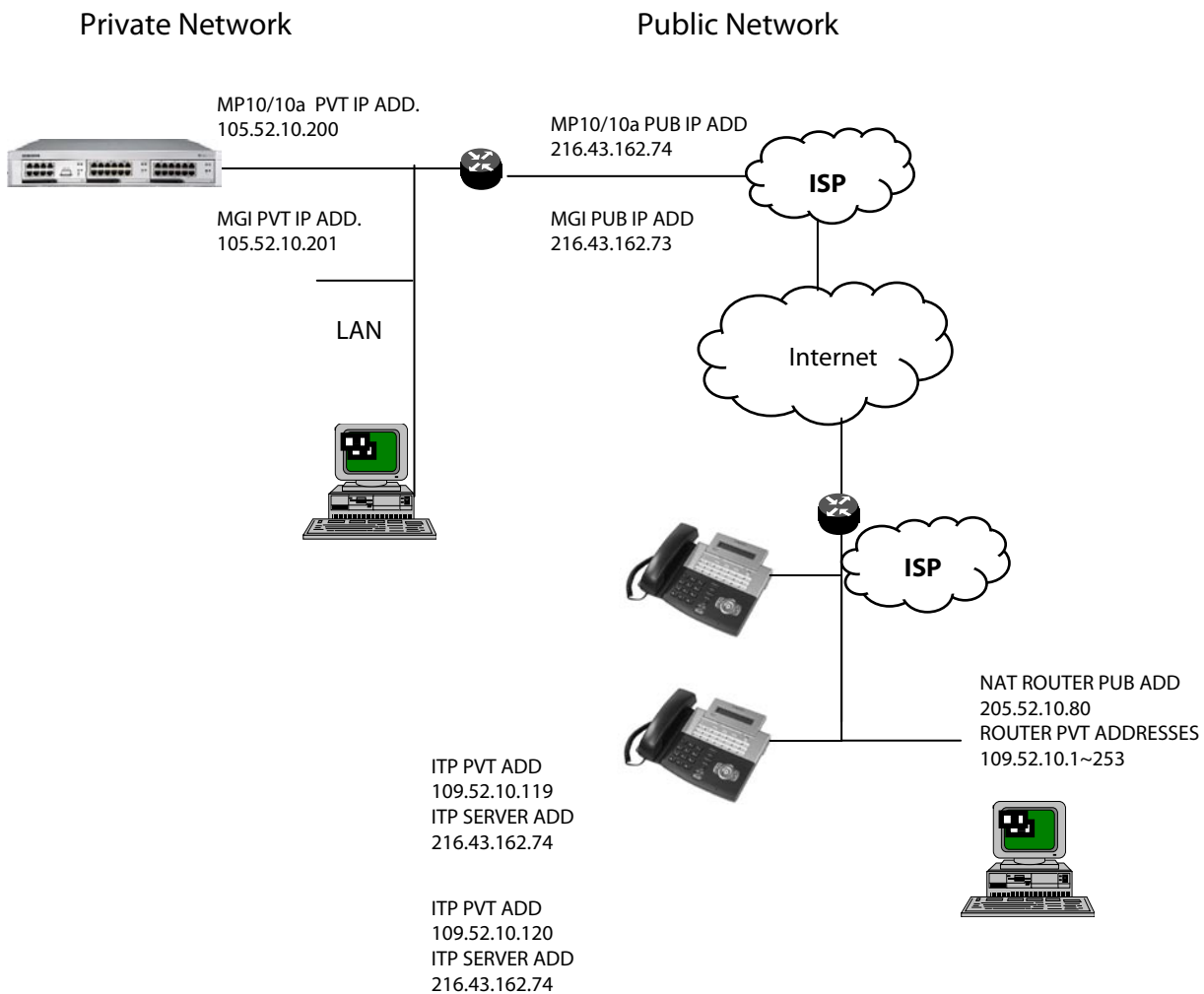
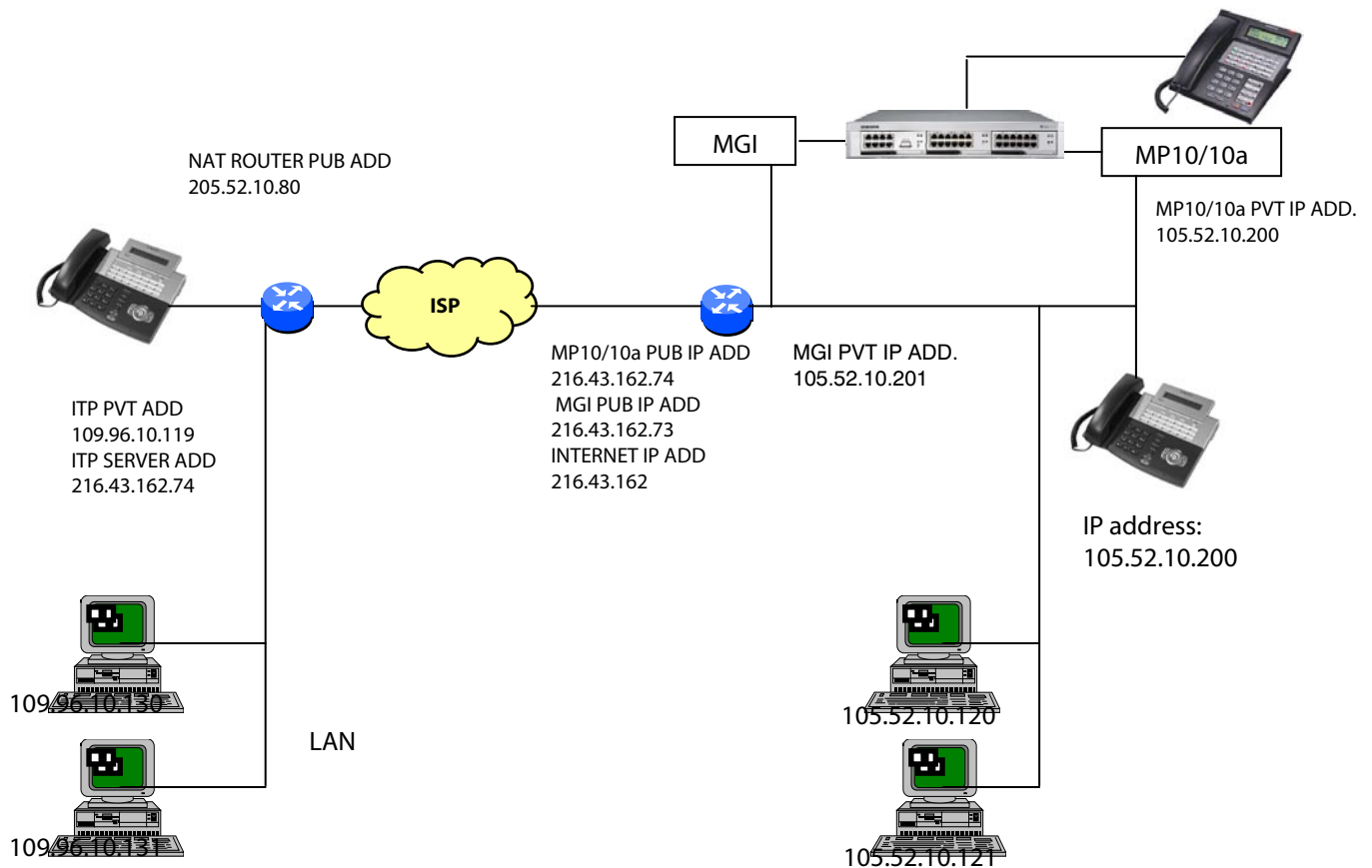

Figure 11b Private with Public Remote NAT Router Connections



Connecting to the Public Network

When connecting to the public network there are several considerations for IP addressing and connectivity.

1. Sufficient bandwidth to support ITP voice and data.
2. Minimum two static IP addresses at the OfficeServ 7100 system side. One to expose the MGI card(s) to the public Internet and a second one to be used for MP10/MP10a communications.
3. A router with the ability to allow IP Reservations or IP Forwarding.
4. Use one of the 3 ways to connect a remote public ITP keyphone:
 - A static IP at remote ITP end OR
 - An ITP keyphone standalone using DHCP services from the ISP OR
 - An ITP keyphone behind a NAT router.

NOTE: If remote ITP has to traverse a firewall or NAT Router to communicate with the MP10/MP10a/MGI, then set:

- MMC 830 and MMC 831: IP type to "Private with Public" set up private and public IP addresses.
- MMC 840: For each remote ITP, set IP type to "Public with Firewall".

Quality of Service

Quality of Service when deploying VoIP is always a consideration. In the IP network environment there are several tools to assist in providing a voice quality that can sometimes be comparable to circuit switched voice. When working via an IP network there are issues that are beyond the control of the communications system.

The main concerns for QoS are Lost Packets, Delay (fixed or variable) and Jitter. To use these terms it must be understood that the quality of voice via IP is based or measured by a Mean Opinion Score (MOS). MOS is a numerical measure of the quality of human speech when using VoIP. Subjective test (opinionated) provide a numerical score to determine voice quality. These scores are based on compression methods and provide a mathematical equivalent to speech quality where 5 is the best and 1 is the worst.

Table 3. MOS Guidelines

Compression	MOS Score	Byte/ms	Bit Rate (Kbps)
G.711	4.5	80/5	64
G.729	3.9	10/10	8
G.729A	3.65	10/10	8
G.723	3.8	24/30	5.5~6.5

Table 4. MOS Quality Assessments

Score	Listening Quality	Listening Effort
5	Excellent	Complete relaxation possible, no effort required
4	Good	Attention necessary, no appreciable effort required
3	Fair	Moderate effort required
2	Poor	Considerable effort required
1	Bad	No meaning understood with any feasible effort

Before applying QoS sufficient bandwidth must be available. A G.711 call over a 64Kbps link will result in a 20% loss of data and provide poor quality. IE. G.711 = 64 kbps payload +16 kbps header = 80 kbps. So, then an 80 kbps packet on a 64 kbps circuit results in 20% loss. Provisioning of bandwidth is an important factor in all VoIP applications.

Network congestion is another source for packet loss and delay. There are tools available in many router operating systems that provide for equal queuing to voice and data packets. Since data packets are smaller and sampled more often, a large data package can consume the time needed to send the voice packets and cause lost or delayed packets. The most

common methods used by router manufactures are Low Latency Queuing, Fair Queuing, Weighted Fair Queuing, RSVP Queuing and Fragmentation. Insuring these options are available will assist in providing a good quality of service.

In all, QoS can be a complicated endeavor when transporting voice over an unmanaged public Internet environment. The OfficeServ 7100 has many tools embedded to allow adjustments for VoIP QoS but they are not the catch-all solution to total network quality which should be governed by the network equipment.

TCP/UDP Ports

In the IP environment ports are used for specific connections. These ports need to be known to traverse **routers**, firewalls and to provide prioritization in certain environments. The IP ports and port types utilized by the OfficeServ 7100 are listed in Table 5.

System TCP/UDP Port numbers

Table 5. OfficeServ 7100 TCP/RTP/UDP Port

Service Type	Port Number	Protocol	Remarks
VoIP Networking	6100	TCP	For connection setup
IP Phone interface (system side)	6000	TCP/UDP	For connection setup
H.323 Gateway	1719	UDP	For connection with Gatekeeper
	1720	TCP	For connection setup
	1024 ~ 4999	TCP	For maintaining TCP Connection
SIP Gateway	5060	UDP	For connection setup
MGI, MGI16	30000~30031	RTP RTCP (also seen as UDP)	Even port: RTP for each MGI channel Odd port : RTCP for each MGI channel
IP Phone (phone side)	6000	UDP	Signaling for MP10/MP10a
	9000, 9001	RTP,RTCP	Voice data for MGI or ITP
CTI	5002	TCP	CTI Connection
Program Upload	5003	TCP	Program upload to Smart Media
Installation Tool	5090	TCP	Connection port for the Installation Tool system programming application.
SMDR Print	5100	TCP	SMDR printout to IP connection
UCD Print	5101	TCP	UCD printout to IP connection

Service Type	Port Number	Protocol	Remarks
Traffic Report	5102	TCP	Traffic Report to IP connection
Alarm Report	5103	TCP	System Alarm Report to IP connection
UCD View	5104	TCP	UCD View printout to IP connection
Periodic UCD	5105	TCP	Periodic UCD printout to IP connection

ITP Application Programming Examples

In the following example shows the private corporate LAN application on the enterprise network. The network is considered “private” because all of the IP addresses are on the same network. In the following example the IP addresses are “static” and were provided by the IT person that manages the IP network.

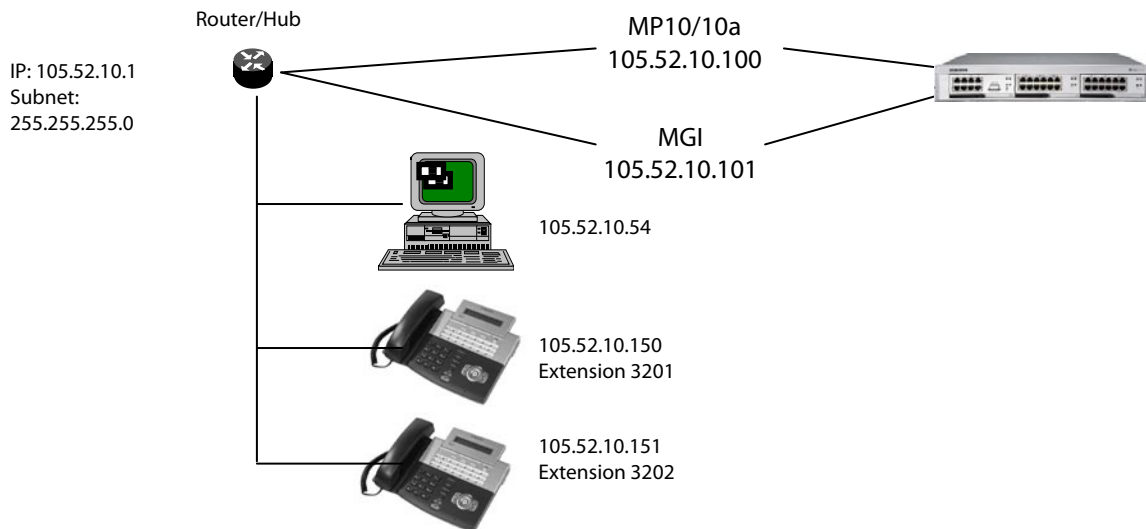

Programming this application on the OfficeServ 7100 system is as follows:

1. MMC 830 ETHERNET PARAMETERS

Note: If you are using on-board MGI channels MMC 831 is “read only”. The MP10/MP10a’s IP will be used for the MGI function also)

- SYSTEM IP ADDR: 105.52.10.100 (MP10/MP10a IP address)
- SYSTEM GATEWAY: 105.52.10.1
- SYSTEM NET MASK: 255.255.255.0
- SYSTEM RESTART: Yes
- SYSTEM IP TYPE: PRIVATE (default)

2. MMC 831 MGI PARAMETERS (If you are using the MGI-16 card)

Note: If you are using on-board MGI channels MMC 831 is “read only”. The MP10/MP10a’s IP will be used for the MGI function also)

- IP ADDRESS: 105.52.10.101
- GATEWAY: 105.52.10.1
- SUB MASK: 255.255.255.0
- PUBLIC IP: Not Applicable (default 1.1.1.1)

3. MMC 840: IP PHONE SETTINGS FOR EACH ITP ON THE PRIVATE NETWORK

- IP TYPE: Private

4. ITP Keysets

The following needs to be entered into each of the ITP keyphones accordingly. For detailed instructions of configuring the ITP keyphone, see the user's guide.

Network – Mode – Manual IP

Network – IP – 105.52.10.150 or 151 (accordingly)

Network – Netmask – 255.255.255.0

Network – Input Def. Gateway – 105.52.10.1

Server – Server IP – 105.52.10.100

Server – Input ID – 3201 or 3202 (accordingly)

Server – Password – 1234 (default)

Exit

MGI Programming MMCs

There are 14 MMCs directly related to the use and operation of the MGI card.

MMC 615 MGI GROUP

Assigns permissions of use for individual MGI ports. Separates range of ports to be allowed for MGI Services

MMC 616 MGI USER

Assigns permissions of use for individual MGI ports. Separates individual ports to be allowed for MGI use. Allow specific stations or trunks to only use the specified MGI port.

MMC 830 ETHERNET PARAMETERS

Assigns MP10/MP10a system IP address, subnet, gateway and MP10/MP10a Public address (if required).

MMC 831 MGI PARAMETERS

Assigns MGI IP address(es), subnet, gateway and Public address (if required).

MMC 832 VoIP OUT DIGITS

Assigns VoIP access codes, access code length, the number of digits to delete or insert, remote end trunk access code and IP selection tables

MMC 833 VoIP IP ADDRESS

Allows assignment of IP addresses in specific tables to route calls to remote destinations

MMC 834 H.323 OPTIONS

This MMC programs incoming call destination type, CLIP table, CID type, auto codec negotiation, call set up and signaling types and other parameters associated with VoIP signaling when using as a trunking gateway.

MMC 835 MGI DSP OPTIONS

Assigns the individual parameters associated with the VoIP DSP operation. Codec type, filtering, input gain, voice volume and RTP (real time transport protocol) parameters.

MMC 836 H.323 GATEKEEPER OPTIONS

This MMC allow the setup parameter to allow the MGI to operate with a network supported by VoIP Gatekeeper(s).

MMC 837 SIP OPTIONS

This MMC programs the SIP protocol parameters.

MMC 838 PRIVATE IP

This MMC programs the IP addresses for devices that are using the H.323 standard within the network.

MMC 840 IP SET INFO

This MMC programs and stores the station number, user ID and password for ITP keyphones. This MMC also shows ITP MAC and IP addresses and is where the ITP keyphones are registered with the OfficeServ 7100.

MMC 841 SYSTEM IP OPTION

This MMC allow new ITP registrations to be disabled and also allows UCD and SMDR to be sent to the CTI link.

2.7 NETWORKING OVER PRI

The following procedures are intended to show how to set up networking between systems only. It is assumed that all the systems to be networked together have already been set up as stand alone systems with LCR and inbound trunks already set up. If these items have not already been set up then some networking features such as Tandem Dialing and DID pass through cannot be made to work.

The first thing that must be done if networking is to work is to determine the numbering scheme for all ports in the total combined network including room for expansion at each of the networked systems. If the total number of stations is going to be less than 150 then a three-digit station numbering scheme can be easily used (extension numbers 201 to 349). However if more than 150 stations are required then it is strongly recommended that a four-digit numbering scheme be used. Doing this will allow all the systems to have the same feature access codes and will reduce the amount of system programming.

Hardware Setup

Connection Type

The type of circuit used to connect two OfficeServ systems together is a “point to point” T1 configured with ESF and B8ZS signaling. The OfficeServ TEPRI card will convert this T1 into a proprietary type of PRI signaling. If Drop and Insert type CSU/DSUs are to be used on the circuit so that the span can be used for data as well then the OfficeServ must have control of channel 24 on the span and voice channels from channel 1 down. For example, if a customer wants to use 8 channels for data and 15 channels for voice, then the OfficeServ has to have control of channels 1 through 15 for voice and channel 24 for signaling.

TEPRI Card DIP Switch Setup

On the DIP switch bank on the TEPRI card switches 1, 2 and 8 must be set to the ON position. If this card is to be the PRI D channel controller card for the span then DIP switch number 4 should also be in the ON position. There can only be one D channel controller on each span.

Software Setup

1. Each switch must be given a unique multi-digit ID number that does not conflict with the North American Dialing Plan. e.g. one switch is ID 001, a second is ID 002, a third is 003, etc. The digits star (*) and pound (#) cannot be used in switch ID numbers, This information is entered in MMC 820.
2. Determine the extension number range(s) for each switch:

e.g. Switch 001 is 2001 → 2199
Switch 002 is 2200 → 2299
Switch 003 is 2300 → 2399

3. Determine the group number ranges for each switch:

e.g. 001 is 5000 → 5049
002 is 5100 → 5149
003 is 5200 → 5249

4. Determine the network LCR access codes from the information in items 2 and 3 above. These are the common leading digits for the station and group numbers in the other switches.

e.g. for switch 001 this would be 22 (so 22XX extensions can be called), 23 (so 23XX extensions can be called), These are for stations in the other systems, 51 (so 51XX groups can be called) and 52 (so 52XX groups can be called), These are for station groups in other systems.

This information is entered in MMC 724 in the network LCR area (NTWK LCR NUMPLAN).

5. Combine the switch ID and the LCR code to create the entries for MMC 824.

e.g. for switch 001 those would be: XXXYY Where

00222	XXX = Switch ID
00251	Y = LCR Access Code
00323	
00352	

As we are using 4 digit extension and group numbers the size field for each entry will be 4.

As we are using 3 digits switch IDs and 4 digit extension and group numbers the max digits field for all entries will be $3 + 4 = 7$

If the networked systems are to use a centralized voicemail system then the switch that has the VMAA will have all the MB entry = Y, all others will be = N.

In our example switch 001 will host the centralized voice mail so the MMC 824 entries for switch 001 will now look like this:

[01:22 → 00222]
[SZ:2 MAX:07 MB:Y]

[02:23 → 00323]
[SZ:2 MAX:07 MB:Y]

And so on for all four entries.

The trunk side of the network intercom dial plan must now be set up to allow LCR to send intercom calls across to the other switch.

6. Put the trunks for each network link into their own trunk group.

e.g. in switch 001 put the trunks to switch 002 in group 802 and the trunks to switch 003 in 803.

7. Using MMC 821 change each network link from "Normal" to "Q-SIG".

8. Set up LCR routes in MMC 712 to allow LCR to access the network links.

e.g. for switch 001 the route could be route 2 to access switch 002 set up as 02:1 C:1 G:802 M: _ _ _
Route 3 to access switch 003 set up as 03:1 C:1 G:803 M: _ _ _

9. Set up the LCR digit tables in MMC 710 to allow access to the network link routes.

e.g. for switch 001 the entries would be:

Digits	Length	Route
002	7	2
003	7	3

In order to receive incoming calls over the network the DID table must be set up.

10. Make entries in the DID digit table MMC 714 for the digits to be received over the network links.

e.g. for switch 001:

Digits	Destination	Delete	Reason
20**	RP1~RP6 = B	0	Intercom Calls to
21**	RP1~RP6 = B	0	Switch 001
22**	RP1~RP6 = 22	2	ICM to 002 from 003
23**	RP1~RP6 = 23	2	ICM to 003 from 002
50**	RP1~RP6 = B	0	Intercom to 001 groups
51**	RP1~RP6 = 51	2	Calls to 002 groups
52**	RP1~RP6 = 52	2	Calls to 003 groups
561	RP1~RP6 = 9	1	tandem local calls

When the 10 steps described above have been completed intercom networking is completed.

Centralized Voice Mail Setup

This setup takes place at each of the remote locations and allows these locations to use the Samsung Voicemail system in the central location. When messages are left at the central location the VMMSG key at the remote location will illuminate to indicate a message. The "new message" counter will not be shown in the keyset displays at the remote location. When the message is returned to the Samsung Voicemail by pressing the VMMSG all navigation must be done by following the audio prompts and dialing digits as the interactive soft keys will not be shown at the remote location.

1. In MMC 825 set the "USE REMOTE VM" option to YES
2. In MMC 825 program the station group for the Samsung Voicemail in the main location under "REMOTE VM NUMBER" e.g. 50-49
3. Confirm that at the main location that the entries in MMC 824 that require voice mail boxes have the MB: option set to Y so that when a VM download is performed these mailboxes and extension id's will be automatically created.

Centralized Operator Setup

This setup allows all dial "0" calls in the remote system to call the operator in the main system. This feature only works with dial "0" calls. Recalls etc. will ring the designated local operator.

1. In MMC 724 under NTKW LCR NUMPLAN make an entry "0", for example:
[NTWK LCR NUMPLAN]
[LCR-03:NONE→0]
2. In MMC 824 for the "0" entry fill out the display as 0010,1,04,N for example:
[03:0 →0010]
[SZ:1 MAX:04 MB:N]
3. In MMC 710 make an entry for digits "0010" , length 04, and the route to access the main location. For example:

[LCR DIGIT (0002)]
[DIGIT:0010]

[LCR DIGIT(0002)]
[LENGTH:04 RT:02]

DID Pass Through

This will allow DID calls that come in on circuits on the main location to ring at the remote locations.

1. In MMC 724 under NTKW LCR NUMPLAN make an entry for an unused station number block for example 30:

[NTWK LCR NUMPLAN]
[LCR-05:NONE→30]

2. In MMC 824 for entry "30" fill out the display to route the calls to switch 002 indicating the total number of DID digits plus the 3 digit access code as the MAX entry as follows:

[05:30 →002]
[SZ:2 MAX:07 MB:N]

3. In MMC 714 tell the incoming DID digits to "ring" 30 for all ring plans
4. Translate the digits on the receiving side in MMC 714 as normal

NOTE: Repeat steps 1 through 4 for each remote switch using a different NTKW access code for each switch.

Tandem Trunking

If the networked switches are in different area codes, e.g.

Switch 001 is 561
Switch 002 is 954
Switch 003 is 305

then calls from one switch can be routed over the network link and sent over as local calls. For example if a user in Switch 001 wants to call a number in the 305 area code the call could be routed over the network link to switch 003 and sent out as a local call. This is called Tandem Trunking.

To achieve this, LCR entries must be created to route the calls as described by modifying the digits and routing the call across the network link.

1. Create LCR entries for each networked Switch area codes.

E.g. for Switch 001 these would be:

Digits	Length	RT
1954	11	05
1305	11	06

2. Create the LCR routes with the digits modified to reflect 7 digit dialing in 954 area code and 10 digit dialing in 305 area code.

Eg. for Switch 001 these would be:

Route	Class	Group	Modify
05:1	1	802	002
06:1	1	803	003

3. Create the modifying digits entries as described in step 2.

Eg. for Switch 001 these would be:

Entry	Del	I	A
002	01	0029	---
003	01	0039	---

These modify digit entries convert the digits dialed by the user into a digit string that will let the destination switch route the call through the DID translation table (MMC 714) to the appropriate local trunk group. This is the group already set up in LCR before networking was applied to allow local calls to be sent out of that switch. For example in switch 001 if local calls go out over trunk group 800 there would be an entry in MMC 714 for digits 561 (switch 001's home area code) to "ring" 800 for each of the ring plans.

NETWORKING DATA COLLECTION FORM

Switch ID: Area Code:
(MMC 820)

Extension Range: to
(MMC 724)

to

to

Station Group Range: to
(MMC 724)

Central Operator Host: Yes No

Central VMAA Host: Yes No

LCR Access Code:
(MMC 724)

Network LCR Access Code
(MMC 724)

Network LCR Table Entries

Entry	Size	Max	MB
-------	------	-----	----

(MMC 824)

<input type="text"/>	<input type="text"/>	<input type="text"/>	<input type="text"/>
----------------------	----------------------	----------------------	----------------------

<input type="text"/>	<input type="text"/>	<input type="text"/>	<input type="text"/>
----------------------	----------------------	----------------------	----------------------

<input type="text"/>	<input type="text"/>	<input type="text"/>	<input type="text"/>
----------------------	----------------------	----------------------	----------------------

<input type="text"/>	<input type="text"/>	<input type="text"/>	<input type="text"/>
----------------------	----------------------	----------------------	----------------------

<input type="text"/>	<input type="text"/>	<input type="text"/>	<input type="text"/>
----------------------	----------------------	----------------------	----------------------

<input type="text"/>	<input type="text"/>	<input type="text"/>	<input type="text"/>
----------------------	----------------------	----------------------	----------------------

<input type="text"/>	<input type="text"/>	<input type="text"/>	<input type="text"/>
----------------------	----------------------	----------------------	----------------------

Network Trunk Group
 (MMC 603)

Switch	Group

Networking Link Access
 (MMC 710)

Digits	Length	Route

Network Routes
 (MMC 712)

Switch ID	Route	Class	Group	Modify

MODIFY DIGITS
 (MMC 713)

Entry	DEL	I	A

DID TABLE (MMC 714)

Digits	RP1	RP2	RP3	RP4	RP5	RP6	Delete

NETWORKING PROGRAMMING EXAMPLE

A company has three locations, its headquarters in 561 area code , a location in 954 area code and a location in 305 area code. 561 and 305 areas are ten digit local dialing and 954 is 7 digit local dialing. There are 150 stations in the headquarters and this system will also host the Samsung Voicemail for the company. The 954 location has 50 sets as does the 305 location. All calls from area code to area code are long distance so calls from any of the locations to the area code of another location must be re routed across the network links and sent out as local calls. The data sheets attached show how the system would be programmed.

NETWORKING DATA COLLECTION FORM-EXAMPLE 1

Switch ID: Area Code:
 (MMC 820)

Extension Range: to
 (MMC 724)

to

to

Station Group Range: to
 (MMC 724)

Central Operator Host: Yes No

Central VMAA Host: Yes No

LCR Access Code:
 (MMC 724)

Network LCR Access Code

Network LCR Table Entries

Entry	Size	Max	MB
-------	------	-----	----

 (MMC 824)

00222	4	7	Y
-------	---	---	---

00252	4	7	Y
-------	---	---	---

00323	4	7	Y
-------	---	---	---

00353	4	7	Y
-------	---	---	---

--	--	--	--

--	--	--	--

--	--	--	--

Network Trunk Group
 (MMC 603)

Switch	Group
002	802
003	803

Networking Link Access
 (MMC 710)

Digits	Length	Route
002	7	3
003	7	4
1305	11	5
1954	11	6

Network Routes
 (MMC 712)

Switch ID	Route	Class	Group	Modify
002	03:1	1	802	
003	04:1	1	803	
TANDEM	05:1	1	802	002
TANDEM	06:1	1	803	003

MODIFY DIGITS
 (MMC 713)

Entry	DEL	I	A
002	01	002	
003	01	003	

DID TABLE (MMC 714)

Digits	RP1	RP2	RP3	RP4	RP5	RP6	Delete
20**	B	B	B	B	B	B	0
21**	B	B	B	B	B	B	0
22**	22	22	22	22	22	22	2
23**	23	23	23	23	23	23	2
50**	B	B	B	B	B	B	0
52**	52	52	52	52	52	52	2
53**	52	52	52	52	52	52	2
561	800	800	800	800	800	800	0

NETWORKING DATA COLLECTION FORM-EXAMPLE 2

Switch ID: Area Code:
 (MMC 820)

Extension Range: to
 (MMC 724)

to

to

Station Group Range: to
 (MMC 724)

Central Operator Host: Yes No

Central VMAA Host: Yes No

LCR Access Code:
 (MMC 724)

Network LCR Access Code
 (MMC 724)

Network LCR Table Entries
 (MMC 824)

Network Trunk Group
 (MMC 603)

Switch	Group
001	801
003	803

Networking Link Access
 (MMC 710)

Digits	Length	Route
001	7	2
003	7	3
1305	11	4
1561	11	5

Network Routes
 (MMC 712)

Switch ID	Route	Class	Group	Modify
001	02:1	1	801	
003	03:1	1	803	
TANDEM	04:1	1	803	002
TANDEM	05:1	1	801	003

MODIFY DIGITS
 (MMC 713)

Entry	DEL	I	A
002	01	003	
003	01	001	

DID TABLE (MMC 714)

Digits	RP1	RP2	RP3	RP4	RP5	RP6	Delete
20**	20	20	20	20	20	20	2
21**	21	21	21	21	21	21	2
22**	B	B	B	B	B	B	0
23**	23	23	23	23	23	23	2
50**	50	50	50	50	50	50	2
52**	B	B	B	B	B	B	0
53**	53	53	53	53	53	53	2
954	800	800	800	800	800	800	3

NETWORKING DATA COLLECTION FORM-EXAMPLE 3

Switch ID: Area Code:
 (MMC 820)

Extension Range: to
 (MMC 724)

to

to

Station Group Range: to
 (MMC 724)

Central Operator Host: Yes No

Central VMAA Host: Yes No

LCR Access Code:
 (MMC 724)

Network LCR Access Code
 (MMC 724)

Network LCR Table Entries
 (MMC 824)

Network Trunk Group
 (MMC 603)

Switch	Group
001	801
002	802

Networking Link Access
 (MMC 710)

Digits	Length	Route
001	7	2
002	7	3
1954	11	4
1561	11	5

Network Routes
 (MMC 712)

Switch ID	Route	Class	Group	Modify
001	02:1	1	801	
002	03:1	1	802	
TANDEM	04:1	1	801	001
TANDEM	05:1	1	802	002

MODIFY DIGITS
 (MMC 713)

Entry	DEL	I	A
001	01	002	
002	01	001	

DID TABLE (MMC 714)

Digits	RP1	RP2	RP3	RP4	RP5	RP6	Delete
20**	20	20	20	20	20	20	2
21**	21	21	21	21	21	21	2
22**	22	22	22	22	22	22	2
23**	B	B	B	B	B	B	0
50**	50	50	50	50	50	50	2
52**	52	52	52	52	52	52	2
53**	B	B	B	B	B	B	0
305	800	800	800	800	800	800	0

2.8 NETWORKING OVER IP

The following procedures are intended to show how to set up IP networking between systems only. This method will allow multiple OfficeServ 7100 systems to be networked together over an IP network. It is assumed that all the systems to be networked together have already been set up as stand alone systems with LCR and inbound trunks already set up. If these items have not already been set up then some networking features such as Tandem Dialing and DID pass through will not work.

This document assumes that the user is knowledgeable in TCP/IP concepts and IP network configuration. It is also assumed that a functioning IP network exists between nodes. The procedures involved in building or setting up this IP network connectivity is beyond the scope of this document. See your data network administrator for details.

Hardware

Each node in the network must have at least one MGI installed. In each system, the MGI cards and the MP10/MP10a cards must be programmed with a unique IP addresses on the network. The nodes can reside on the same IP network or different IP networks as long as each MP10/MP10a and MGI in each system can communicate with the MP10/MP10a's and MGI's in all the other nodes and with each other over an IP network. Ping tests are the best way to verify this. From a computer attached to the same network segment that one of the nodes is on, ping the IP addresses of the other node's MP10/MP10a and MGI's as well as the IP addresses of the MGI's and MP10/MP10a on the local node.

If the pings are successful, then it verifies that the communication path is good between devices. However, this does not guarantee other performance related requirements (ie. sufficient bandwidth to handle voice traffic, delay, jitter control, etc...). Some routers and firewalls may have disabled the ability to reply to a ping. Verify this with the data administrator.

The first thing that must be done is to determine the numbering scheme for all ports in the total combined network including room for expansion at each of the networked systems. If the total number of stations is going to be less than 150 then a three-digit station numbering scheme can be easily used (extension numbers 201 to 349). However if more than 150 stations are required then it is strongly recommended that a four-digit numbering scheme be used. Doing this will allow all the systems to have the same feature access codes and will reduce the amount of system programming.

Software Setup

The following MMC's must be programmed for each node in the network:

1. The following MMC's related to IP and MGI set up must be programmed **MMC 830. System IP Address for MP10/MP10a.**

Configure the MP10/MP10a with the relevant IP information:

- Assign IP Address, Default Gateway, and Subnet Mask, then restart the system for the changes to take effect.
- Select IP type (private, public, or private with public) and assign public IP if applicable.

MMC 831. MGI PARAMETERS

Note: If you are using the on-board MGI channels, this is a "Read-Only" MMC. The settings here will be the same as MMC 830.

Configure the MGI card with the relevant IP information:

- Assign IP Address, Default Gateway, Subnet Mask for each MGI card, then restart the MGI card/s for the changes to take effect. Card can be reset using the reset option in MMC 831.
- Select IP type (private, public, or private with public) and assign public IP if applicable.

MMC 835. MGI DSP Options

Configure the MGI card with the relevant IP information:

- AUDIO CODEC must be set for G.729A in each node for IP networking

MMC 615. MGI Use Group

Add the IP trunk members (MGI Channels) for the VoIP Networking function.

1. USER field should be set to "VoIP Networking". Select the IP trunk members for this function. Each IP trunk represents an MGI channel.

MMC 616. MGI Fixed User

If needed you can use this MMC to permanently dedicate MGI channels for a specific function. These settings will over-ride the functional assignments in MMC 615. For example, you can assign channels 3801 and 3802 to always be used only for the "VoIP Networking" function.

2. Each switch must be given a unique multi-digit ID number that does not conflict with the North American Dialing Plan. e.g. one switch is ID 001, a second is ID 002, a third is 003,

etc. The digits star (*) and pound (#) cannot be used in switch ID numbers, This information is entered in MMC 820.

MMC 820. System Link ID

- Link ID : System node ID to distinguish systems in the network. It can not be duplicated. Assign a unique node ID for each system in the network including one for the node you are on ("SELF").
- Signal G/W: For VoIP networking, all IP addresses for the connected systems should be assigned. The IP address for the current node should also be assigned for SELF.
- IP Type : IP type connected through VoIP networking should be assigned.
- Assign the id for all other nodes
- When a call is placed on the networking trunk, the system usually regards the number as node number + station number. If the node number is identified with the self node number, the system removes the node number and places the call according to MMC 714. If not, forwards the call to another system according to MMC 710 (Tandem Call). If there is no identified number, the system regards it as the station number and places the call according to MMC 714.

3. Determine the extension number range(s) for each switch:

e.g.Switch 001 is 2001 → 2199
Switch 002 is 2200 → 2299
Switch 003 is 2300 → 2399

Determine the group number ranges for each switch:

e.g.001 is 5000 → 5049
002 is 5100 → 5149
003 is 5200 → 5249

4. Determine the network LCR access codes from the information in items 2 and 3 above. These are the common leading digits for the station and group numbers in the other switches.

e.g. for switch 001 this would be 22 (so 22XX extensions can be called), 23 (so 23XX extensions can be called), These are for stations in the other systems, 51 (so 51XX groups can be called) and 52 (so 52XX groups can be called), These are for station groups in other systems.

This information is entered in MMC 724 in the network LCR area (NTWK LCR NUMPLAN).

MMC 724. Numbering Plan

- STN DIAL NO.: A non-conflicting range of station numbers should be assigned across all the nodes in the network.
- STNG DIAL NUMBER: A non-conflicting range of station group numbers should be assigned across all the nodes in the network.
- NTKWK LCR DIAL NO: Numbers used to call a station in another system are assigned. This number is converted to node number + station number in MMC 824, and placed in the destination.
- VOIP NET DIAL NO: For VoIP networking, these are virtual trunks for signaling. They should be assigned to trunk groups in MMC 603.
- MGI DIAL NO: These are the channel numbers of the MGI card for voice. They do not need to be set for networking, but should be assigned in the VoIP network group in MMC 615.

5. MMC 824. Networking LCR Translation

For this program, networking dial number in MMC 724 should be assigned. When index 01 is assigned "22" in networking, dial number in MMC 724, ❶ is displayed.

Enter like ❷ for the conversion to node number + station number.

❶	01:22 → SZ:0 MAX:00 MB:N	❷	01:22 →09122 SZ:4 MAX:07 MB:N
---	-----------------------------	---	----------------------------------

In ❷, the meaning of each field is as follows.

- 01: Index for NTKWK LCR DIAL NO in MMC 724.
- 22: NTKWK LCR DIAL NO in MMC 724.
- 09122: Node number (091) + station number(22). The system whose node id is "091" has the station numbers 2200 ~ 2299. Added node number should be assigned to "DIGIT" in MMC 710.
- SZ:4 means the user dials 4 digits when he/she calls node number "091" + station number starting "22".
- MAX:07: Total number of digits in node number + station number. This is very important in "ENBLOCK" dial. When the system receives 7 digits, it does not wait for more digits and makes the call using LCR.
- MB:N: When using Centralized Voice Mail using SVMi-4E/8E/16E cards, other systems need to manually create mail boxes for each system. If this option is "Y", the system creates up to 100 mail boxes for the phone numbers which starts with the numbers assigned in MMC 724, with a length specified by the value of "SZ". That is, it makes 100

mail boxes of 2200~2299 automatically.

Combine the switch ID and the LCR code to create the entries for MMC 824.

e.g. for switch 001 those would be: XXXYY Where

00222

XXX = Switch ID

00251

Y = LCR Access Code

00323

00352

Since we are using 4 digit extension and group numbers, the size field for each entry will be 4.

Since we are using 3 digit switch IDs and 4 digit extensions and group numbers, the max digits field for all entries will be $3 + 4 = 7$.

If the networked systems are to use a centralized voicemail system then the switch that has the VMAA will have all the MB entry = Y, all others will be = N.

In our example switch 001 will host the centralized voice mail so the MMC 824 entries for switch 001 will now look like this:

[01:22 → 00222]

[SZ:2 MAX:07 MB:Y]

[02:23 → 00323]

[SZ:2 MAX:07 MB:Y]

And so on for all four entries.

The trunk side of the network intercom dial plan must now be set up to allow LCR to send intercom calls across to the other switch.

6. **MMC 210:** Tenant On and Off: LCR ENABLE: Set to ON to enable Least Cost Routing.
7. **MMC 310:** LCR CLASS: Assigns the LCR class. If there is only one path connected to another system, it is set to 1(default).
8. **MMC 603:** TRUNK GROUPS: For VoIP networking, all VoIP signaling trunks are assigned to one group. VoIP signaling trunks are the virtual trunks specified in "VOIP NET NUM PLAN" in MMC 724.
9. Put the trunks for each network link into their own trunk group.
e.g. in switch 001 put the trunks to switch 002 in group 802 and the trunks to switch 003 in 803.
10. Set up LCR routes in MMC 712 to allow LCR to access the network links.

MMC 712. LCR Route Table

Route table to select trunks for LCR.

The meaning of each field is as follows.

- (01~32) : Index numbers of route tables.
- (1~4): Time table number assigned in MMC 711.
- C: LCR class assigned in MMC 310.
- G : Trunk group number.
- M : The modified table number in MMC 713 that is in need of modification.
- Assuming, the user usually uses VoIP networking, but uses PRI networking only when VoIP signaling trunks are not available, LCR class in MMC 310 should be 2 or higher, and "C:1 G:801", "C:2 G:802". Here, 801 is a trunk group consisting of VoIP signaling trunks and 802 is trunk group consisting of networking PRI trunks.

e.g. for switch 001 the route could be route 2 to access switch 002 set up as 02:1 C:1 G:802 M:___

Route 3 to access switch 003 set up as 03:1 C:1 G:803 M:___

MMC 713. LCR Modify Table

Assigned when conversion is needed for outgoing call.

The meaning of each field is as follows.

- (001~200): Index numbers of translation tables.
- NOF DEL DGT: Number of digits which will be deleted. Only beginning of digits can be deleted.
- I: Digits inserted in front of the outgoing digits, if needed.
- A: Digits appended behind the outgoing digits, if needed.

11. Set up the LCR digit tables in MMC 710 to allow access to the network link routes.

MMC 710. LCR Digit Table

Assigns route table according to the numbers entered.

The meaning of each field is as follows.

- (0001~2000) : Index numbers.
- DIGIT : Beginning of digits for outgoing call. Because a networking call should have a node number, it can be the starting point. It should be included in the numbers assigned in MMC 824.
- LENGTH : The system does not send digits to the trunk, until "LENGTH" of digits are collected.

RT: Route table number assigned in MMC 712.
e.g. for switch 001 the entries would be:

Digits	Length	Route
002	7	2
003	7	3

In order to receive incoming calls over the network the DID table must be set up.

MMC 711. LCR Time Table: IF YOU ARE NOT USING THIS TABLE, YOU MUST STILL ENTER 0000 for HHMM and set LCRT=1.

Assigns 4 time zones for each date of the week for LCR.

The meaning of each field is as follows.

- SUN~SAT: Sunday to Saturday.
- A~D: 4 time zones.
- HHMM: Time in 24 hour mode.
- LCRT: Time table number used in MMC 712.

12. Make entries in the DID digit table MMC 714 for the digits to be received over the network links.

MMC 714. DID Destination

Assigns an incoming DID call to a specific ring plan destination. The destination includes a station, station group, trunk, trunk group, LCR number, and networking dial number.

The meaning of each field is as follows.

- (001~999): Index numbers.
- DGT: Numbers which will be received. '*' means any digit between '0'~'9'.
- MOH SOURCE: Assigns MOH which will be used according to the received number. If None, it works according to MMC 409.
- 1~6 : Assigns a specified station or group which will receive the call according to the ring mode 1~6. B means a station, station group, trunk or trunk group which is the same number with the received one.
- CW : For Call Waiting. This is not used for networking.
- DELETE: The number of digits to delete.
- NAME: The name of the DID table.

e.g. for switch 001:

Digits	Destination	Delete	Reason
20**	RP1~RP6 = B	0	Intercom Calls to
21**	RP1~RP6 = B	0	Switch 001
22**	RP1~RP6 = 22	2	ICM to 002 from 003
23**	RP1~RP6 = 23	2	ICM to 003 from 002
50**	RP1~RP6 = B	0	Intercom to 001 groups
51**	RP1~RP6 = 51	2	Calls to 002 groups
52**	RP1~RP6 = 52	2	Calls to 003 groups
561	RP1~RP6 = 9	1	tandem local calls

When the 10 steps described above have been completed intercom networking is completed.

Centralized Voice Mail Setup

NOTES

1. The OfficeServ 7100 does not support the SVMi-20E card. However, the OfficeServ 7100 can be a remote system that used the Centralized Voicemail off of another node. All references to SVMi and Centralized Voicemail in this document refers to SVMi/Centralized Voicemail installed in other nodes such that the OfficeServ 7100 is a remote node using the Centralized Voicemail resources remotely via the SPNET.
2. It is recommended that the embedded OfficeServ 7100 Voicemail NOT be used as the Centralized Voicemail.

This setup takes place at each of the remote locations and allows these locations to use the SVM system in the central location. When messages are left at the central location the VMMSG key at the remote location will illuminate to indicate a message. The "new message" counter will not be shown in the keyset displays at the remote location, unless all nodes are running 2.3x software or higher. When the message is returned to the SVM by pressing the VMMSG all navigation must be done by following the audio prompts and dialing digits as the interactive soft keys will not be shown at the remote location, unless all nodes are running 2.3x software or higher.

- In MMC 825 set the "USE REMOTE VM" option to YES
- In MMC 825 program the station group for the SVM in the main location under "REMOTE VM NUMBER" e.g. 50-49

- Confirm that at the main location that the entries in MMC 824 that require voice mail boxes have the MB: option set to Y so that when a VM download is performed these mailboxes and extension id's will be automatically created.
- Make sure you have created mailboxes for the remote node stations on the SVMi using MMC 740 (or SVMi Mailbox Administration). Create these mailboxes on the system where the SVMi resides.

Centralized Operator Setup

This setup allows all dial "0" calls in the remote system to call the operator in the main system. This feature only works with dial "0" calls. This is accomplished by changing the attendant destination in MMC 825.

DID Pass Through

This will allow DID calls that come in on circuits on the main location to ring at the remote locations.

- In MMC 724 under NTKW LCR NUMPLAN make an entry for an unused station number block for example 30:

```
[NTWK LCR NUMPLAN]  
[LCR-05:NONE→30 ]
```

- In MMC 824 for entry "30" fill out the display to route the calls to switch 002 indicating the total number of DID digits plus the 3 digit access code as the MAX entry as follows:

```
[05:30 →002 ]  
[SZ:2 MAX:07 MB:N]
```

- In MMC 714 tell the incoming DID digits to "ring" 30 for all ring plans
- Translate the digits on the receiving side in MMC 714 as normal

NOTE: Repeat steps 1 through 4 for each remote switch using a different NTKW access code for each switch.

Tandem Trunking

If the networked switches are in different area codes, e.g.

```
Switch 001 is 561  
Switch 002 is 954  
Switch 003 is 305
```

then calls from one switch can be routed over the network link and sent over as local calls. For example if a user in Switch 001 wants to call a number in the 305 area code the call could be

routed over the network link to switch 003 and sent out as a local call. This is called Tandem Trunking.

To achieve this, LCR entries must be created to route the calls as described by modifying the digits and routing the call across the network link.

- Create LCR entries for each networked Switch area codes.

E.g. for Switch 001 these would be:

Digits	Length	RT
1954	11	05
1305	11	06

- Create the LCR routes with the digits modified to reflect 7 digit dialing in 954 area code and 10 digit dialing in 305 area code.

Eg. for Switch 001 these would be:

Route	Class	Group	Modify
05:1	1	802	002
06:1	1	803	003

- Create the modifying digits entries as described in step 2.

Eg. for Switch 001 these would be:

Entry	Del	I	A
002	01	0029	---
003	01	0039	---

These modify digit entries convert the digits dialed by the user into a digit string that will let the destination switch route the call through the DID translation table (MMC 714) to the appropriate local trunk group. This is the group already set up in LCR before networking was applied to allow local calls to be sent out of that switch. For example in switch 001 if local calls go out over trunk group 800 there would be an entry in MMC 714 for digits 561 (switch 001's home area code) to "ring" 800 for each of the ring plans.

PROGRAMMING EXAMPLE:

This example demonstrates the steps involved in networking 2 nodes (Nodes A and B) together over IP. It is assumed that a functional IP network exists between the nodes. This physical network segment can be as simple as a single hub or switch, or can be as complex as a network involving routers, switches, firewalls, etc. For simplicity, it will be assumed that both nodes reside on a local network segment 192.168.1.0.

****See your Data Network Administrator to ensure that the MP10/MP10a's and MGI cards can communicate with each other over TCP/IP. If using the on-board MGI channels, the MGI will share the same IP configuration as the MP-10. This example assumes that nodes A & B (OS 7100) are OS 7100's using the on-board MGI.*

NODE A:

Node id: 091
Station numbering plan: 2000~2099
VoIP Network trunk group: 803
MP-10/MGI IP: 192.168.1.2

NODE B (OS 7100)

Node id: 092
Station numbering plan: 2100~2399
VoIP Network trunk group: 803
MP-10/MGI IP: 192.168.1.4

NODE A Programming:

- **MMC 830:** Program the IP information for MP10/MP10a.
IP address: 192.168.1.2
Gateway: 192.168.1.1
Subnet mask: 255.255.255.0
*** Now select the reset option to reset the MP10/MP10a
- **MMC 831:** "Read Only". Displays same IP information as programmed in MMC 830.
- **MMC 615:** Program the MGI Use Groups.
Set USER=VoIP Networking and choose the IP trunk members (MGI channels) to be used for this "Networking" use. The default values should start with member 1 = 3801, etc.
- **MMC 820:** Program the following values for LINK ID, SIGNAL G/W (enter the MP10/MP10a IP address for each node), and IP type for each node as follows (SELF refers to the current node you are programming):

Index	Link ID	Signal G/W	IP Type
SELF	091	192.168.1.2	Private
SYS01	092	192.168.1.4	Private

- **MMC 724:** Set up the numbering plans. Trunk group 803 will contain all the IP networking trunks.

STN NUM PLAN	Station numbers (2000 ~ 2099)
TRKG NUMBER PLAN	803 (Add other trunk groups here if other trunk cards are installed. For simplicity, only 803 will be added here.)
FEAT Dial Number	LCR 9 For C.O. outgoing calls, 9 + phone number
NTWK LCR NUMPLAN	IDX-01 : 21 Converted to 2100~2199 in MMC 824
	IDX-02 : 22
	IDX-03 : 23

- **MMC 210:** Tenant On and Off: For LCR ENABLE: Set to ON to enable Least Cost Routing. Set ICM EXT FWD to ON.

- **MMC 824:** Set up the extension dialing plan for the networked system (node B). 092 is the node id for Node B. **Be sure to set DISP=Y.**

Index	Station	Converted	SZ	Max	MB	DISP	
01	21	09221	4	7	N	Y	Stations in Node B
02	22	09222	4	7	N	Y	
03	23	09223	4	7	N	Y	

- **MMC 714:**

Entry	Digit	MOH	1~6	CW	Delete	Name
001	20**	-	B	-	0	-
002	21**	-	B	-	0	-
003	9	-	9	-	1	-

- **MMC 310:** LCR class of all stations are set to 1 (default) since there is only one path to the other Node.

- **MMC 603:**

803 VoIP networking signaling trunks

- **MMC 710:**

Index	Digit	Length	LCRT	
0001	092	7	1	stations, station groups in system B
0002	1	3	4	special numbers
0003	2	7	4	local calls need at least 7 digits (if needed)

Note: this example does not have local CO trunking.

- **MMC 711:** You MUST Set HHMM= 0000, LCRT=1 for each day of the week unless specific times and days are required to be set.

- **MMC 712:**

Table	Time	Class	Route	Modify
01	1	1	803	Calls group 803

- **MMC 825:**

ADD Number To Name	Yes
Use Remote Voice Mail	No
Remote CID Number	Yes

- **MMC 823:** Set CCNR and CCFB to Yes for certain features to work across the network.

NODE B Programming:

- **MMC 830:** Program the IP information for MP10/MP10a.
 IP address: 192.168.1.4
 Gateway: 192.168.1.1
 Subnet mask: 255.255.255.0
*** Now select the reset option to reset the MP10/MP10a
- **MMC 615:** Program the MGI Use Groups.
 Set USER=VoIP Networking and choose the IP trunk members (MGI channels) to be used for this "Networking" use. The default values should start with member 1 = 3801, etc...
- **MMC 820:** Program the following values for LINK ID, SIGNAL G/W (enter the MP10/MP10a IP address for each node), and IP type for each node as follows (SELF refers to the current node you are programming):

Index	Link ID	Signal G/W	IP Type
SELF	092	192.168.1.4	Private
SYS01	091	192.168.1.2	Private

- **MMC 724:** Set up the numbering plans. Trunk group 803 will contain all the IP networking trunks.

STN NUM PLAN	Station numbers (2100 ~ 2399)
TRKG NUMBER PLAN	803 (Add other trunk groups here if other trunk cards are installed. For simplicity, only 803 will be added here.)

FEAT Dial Number LCR 9 For C.O. outgoing calls, 9+phone number
NTWK LCR NUMPLAN IDX-01:20 converted to 2000~2099 in MMC 824

- **MMC 210:** Tenant On and Off: For LCR ENABLE: Set to ON to enable Least Cost Routing. Set ICM EXT FWD to ON.
- **MMC 824:** Set up the extension dialing plan for the networked system (node A). 091 is the node id for Node A. **Be sure to set DISP=Y.**

Index	Station	Converted	SZ	Max	MB	DISP	
01	20	09120	4	7	N	Y	Stations in Node A

- **MMC 714:**

Entry	Digit	MOH	1~6	CW	Delete	Name
001	20**	-	B	-	0	-
002	21**	-	B	-	0	-
003	9	-	9	-	1	-

- **MMC 310:** LCR class of all stations are set to 1 (default) since there is only one path to the other Node.

- **MMC 603:**

803 VoIP networking signaling trunks

- **MMC 710:**

Index	Digit	Length	LCRT	
0001	091	7	1	stations, station groups in Node A
0002	1	3	4	special numbers
0003	2	7	4	local calls need at least 7 digits (if needed)

Note: this example does not have local CO trunking.

- **MMC 711:** Set HHMM= 0000, LCRT=1 for each day of the week unless specific times and days are required to be set.

- **MMC 712:**

Table	Time	Class	Route	Modify
01	1	1	803	—

- **MMC 825:**
ADD Number To Name Yes
Use Remote Voice Mail No
Remote CID Number Yes
- **MMC 823:** Set CCNR and CCFB to Yes for certain features to work across the network.
- **MMC 835:** You must set AUDIO CODEC to G.729A for IP Networking. DTMF TYPE should be set to the same setting on each node (INBAND or OUT of BAND)

Now you should be able to dial a 4 digit extension from Node A to a station in Node B (and vice-versa).

2.9 NETWORKING

The networking feature package allows up to 99 OfficeServ 7100 systems to be connected together with a high level of feature transparency. The physical connection between the systems can be set up via an IP network or a proprietary PRI connection (based on Q-SIG specification). The following feature enhancements are supported between networked systems.

- **Auto Answer Accross Network:** This setting will allow station to station calls across the network to follow the auto answer setting of the called keyset.
- **Call Completion, Busy Station (CCBS)** also known as Callback or Busy Station Callback. When a station in one system calls a station in another system across the network link and the destination station is busy the calling station can set a Callback to the busy station. When the busy station becomes idle the system will notify the callback originating station by ringing that station and when the originating station answers, the system will call the destination station. Not available on QSIG over PRI.
- **Call Completion, No Response (CCNR)** also known as Callback or No Answer Callback. When a station in one system calls a station in another system across the network link and the destination station does not answer the calling station can set a Callback to the called station. When that station indicates the user is present by becoming busy then idle the system will notify the callback originating station by ringing that station and when the originating station answers, the system will call the destination station.
- **Forward External:** This feature operates in the same manner as a non networked system with the exception that, because calls across a network link are trunk calls, network calls do not follow the ICM FWD EXT ON/OFF setting in MMC 210. It is therefore suggested that this setting be set to ON in a networked switch to avoid confusion in operation between networked and non networked calls.
- **Call Intrusion (Barge In):** Calls across the network link can be barged in on however the barging station will not be muted.
- **Call Offer/Call Waiting (Camp On):** This feature operates in the same manner as in a non networked switch. When a called station is busy the caller can press a camp on key and appear as a ringing call on the second call button. The Auto camp on feature will not work on calls across a network link if set to ON in MMC 110.
- **Call Transfer:** Calls answered in one network node can be transferred to a station or station group in another network node.
- **Transfer Retrieve:** Calls on Transfer Hold during a screened transfer can be retrieved by pressing the call button for that call.
- **Transfer Recall:** Calls transferred across a network link will recall to the transferring station after the originating system transfer recall timer expires. After recalling, if not

answered prior to that systems attendant recall timer expiring, the call will recall to that systems designated operator group. Attendant recalls will not recall to a 'Centralized Attendant'.

- **DID with Pass Through:** Incoming DID, DNIS or DDI calls can be routed through one switch across a network link to be processed by the DID table of the destination switch.
- **Do Not Disturb (DND):** This feature operates in the same manner as in a non networked switch.
- **Caller ID:** Caller ID in its various forms that are currently available (Analog CID Name and Number, ANI Number, PRI Name and Number and BRI number) will be transported across the network link with the original call.
- **Centralized Attendant:** This feature basically allows a user in any switch to dial "0" and ring at the designated Central attendant group. Each system on the network requires its own designated attendant group for local usage, recalls and the like.
- **Intercom Calling/Uniform Dialing Plan:** Station to station and station to group calls can be made across the network link without having to dial an access code for a call within the network. LCR can also be programmed to route calls across a network link and to access local trunks in another networked system.
- **Centralized Voice Mail with Message Waiting Lights:** This feature will only operate with SVMi voicemail systems only. Users in one node can call forward to the SVMi group in a different switch and messages left in that switch will be indicated on the VMSG key in the origination switch. Messages can be returned to the SVMi by pressing the VMSG key.

NOTES

1. The OfficeServ 7100 does not support the SVMi-20E card. However, the OfficeServ 7100 can be a remote system that used the Centralized Voicemail off of another node. All references to SVMi and Centralized Voicemail in this document refers to SVMi/Centralized Voicemail installed in other nodes such that the OfficeServ 7100 is a remote node using the Centralized Voicemail resources remotely via the SPNET.
2. It is recommended that the embedded OfficeServ 7100 Voicemail NOT be used as the Centralized Voicemail.

Enhanced Networking

OfficeServ 7100 also supports the following Enhanced Networking features:

NETWORK TRUNK RING DESTINATION

This feature permits for analog trunks to be assigned to ring at any station or group destinations anywhere in the network. Trunk facilities terminating at the main office location can be assigned to ring directly at stations, station groups, or single line ports in the branch offices. This feature provides greater flexibility for networking customers to share incoming trunk facilities across the corporate network.

Notes:

- The ring destination for local and remote stations or station groups must be assigned in the system where the trunks facilities are terminated.
- Remote stations and group numbers from anywhere in the network can be assigned in MMC 406 of the source node of the connecting trunks.
- Any trunks not assigned a specified ring destination in MMC 406 will default ring to the operator group.
- When CID is present, the CID information is passed across the network.
- This feature is supported over Q-sig and IP networking.
- MMC 406 is primarily used to terminate analog lines. Digital trunks will not follow the setting of MMC 406, but will follow the setting of MMC 714.

MMC INFORMATION: [MMC 406](#) (set trunk ring destination)

CENTRALIZED ATTENDANT: This feature permits for an Attendant position to be assigned to handle second level recalls (hold/e-hold/transfer/campon/park) from local operators of other nodes within the network. The way this feature operates is transferred and held calls will first recall to the station that performed the transfer or placed the call on hold. After the preset timer expires (transfer recall or hold recall timer) the transfer/held calls will then recall to central attendant instead of recalling to the local operator.

An additional option is available for centralized attendant that allows the remote attendant recall destination to be determined by time of day. This is accomplished by selecting the remote attendant destination and which ring plan the attendant recalls will follow. An example would be during normal working hours, transfer and hold recalls from stations in the branch office will recall to the main attendant at the main office location. When the attendant at the main office goes home at 5:00pm, the recalls from the branch office can be automatically rerouted to a local attendant or local station within the branch office that is still on duty after 5:00pm. This is accomplished by changing the attendant destination on a per ring plan basis in MMC 825.

Notes:

- Centralized attendant handles second level recalls across the network. This is not to be confused with centralized operator which handles calls from remote stations dialing 0.
- Centralized attendants can only be assigned on a per node basis. Each node in the network can have a local attendant or a centralized attendant, but not both.
- Attendant recall destination can be changed by time of day by selecting ring plans and recall destinations in MMC 825.
- This feature is supported over Q-sig and IP networking.

MMC INFORMATION:

[MMC 825:](#) USE CENT ATT: RING1-6, YES/NO). This is used to set each node to use attendant of a remote system.

[MMC 825:](#) (REMOTE ATTN NUM:RING1-6, XXXX). This is used to assign the station number or attendant group of the remote attendant that second level recalls will be routed.

[MMC 501:](#)

(E-HOLD RECALL TM) This timer controls the duration of time a call is held exclusively at a station before recalling.

(SYS HOLD RECALL) This timer determines the time calls can be left on hold before recalling back to the holding station. This is a system-wide timer. Setting timer to 000 will defeat this feature and no recalling will take place.

(TRANSFER RECALL) This timer determines the time transferred calls ring before recalling. This is a system-wide timer.

(PARK RECALL TIME) This timer controls the duration of time a call is parked before recalling to the call park originator.

(CAMP ON RECALL) This timer controls the duration of time a camped-on call will stay at a destination before recalling to the transferring station.

(ATT. RECALL TIME) This is the length of time a transfer recall will ring at a station before recalling the local operator or Centralized Attendant.

(RECALL WAIT TIME) This is the time any recall (hold or transfer) continues to recall at your station before it recalls to the local operator or Centralized Attendant.

UCD FINAL/INVALID DESTINATION NETWORK ROUTING

This feature has been improved to allow UCD groups to overflow unanswered calls to other stations or station groups anywhere in the network. For example, call arriving at the branch office can ring to a UCD; if the call goes unanswered for a predetermined time period, the call will then overflow, and ring to the final destination. The final destination can now be programmed as a station number or group number in the main office or any other station or station group in the network.

Notes:

- Station groups must include local station only. Network groups are not supported. Station groups cannot include members from different nodes
- Only the final destination or invalid destination setting can include network station or station groups.
- When CID is present, the CID information is passed across the network.
- This feature is supported over Q-sig and IP networking.

MMC INFORMATION:

[MMC 607](#) (set UCD FINAL DEST)

[MMC 733](#) (set INVLID DEST)

GROUP OVERFLOW ACROSS THE NETWORK

This feature allows the overflow destination for a station group to exist in the same node or a remote node within the network. An example of how this works is this feature will allow calls to arrive and ring at the branch office. If the call is not answered by any member of the branch office group within a preset time period, the calls will then leave the branch office and overflow to a station group in the main office.

Notes:

- Station groups must include local stations only. Network groups are not supported.
- Station groups cannot include members from different nodes.
- Only the next port, final destination or invalid destination setting can include network station groups.
- When calls ringing at the originating group in one node overflow to a backup station group in another node, the calls will stop ringing at the originating node and will only ring at the overflow destination. The calls will not ring at the originating station group and the overflowed group simultaneously.
- The Group overflow feature only supports overflowing to other station group. Individual extensions or virtuals from another node cannot be assigned as a network overflow destination.

- Calls are allowed to ping-pong from one network node to another. For example a call can ring a station group in the originating node, overflow to a station group in another node, and then overflow back to the originating node or station group.
- Calls to station groups of the originating node can be overflowed to a centralized voicemail group within another node on the network.
- When incoming calls with caller ID are presented to the originating group, the caller ID information is passed on the overflow destination.
- This feature is supported over Q-sig and IP networking.

MMC INFORMATION:

[MMC 601](#) set "OVERFLOW timer" and assign "NEXT PORT" destination.

CENTRALIZED VOICEMAIL WITH SOFT KEY FUNCTIONALITY

This enhancement allows all users within the network that are using the SVMi() centralized voicemail to use the softkey options to navigate through the voicemail functions. For example, when a user calls voicemail to retrieve messages, softkey options such as FAST FORWARD, REVIEW, PLAY, SAVE, DELETE are displayed to the keyset users. This offers a new level of flexibility to centralized voicemail. Stations in branch offices that do not have an SVMi() card installed can share most of the voicemail functions of the main office. Station users in remote office using centralized voicemail will not require any additional training because voicemail operation is the same for local and remote users.

Notes:

- The functionality is only available when using the SVMi() card for Centralized Voicemail.
- Softkey options are only available to the Samsung digital stations.
- This feature is supported over Q-sig and IP networking.

MMC INFORMATION:

[MMC 825](#) (USE REMOTE VM=YES/NO) set to YES for remote nodes using centralized voicemail.
[MMC 825](#) (REMOTE VM NUMBER= XXXX) in remote nodes, enter voicemail station group number of centralized voicemail.

VOICEMAIL TRANSFER (VT) ACROSS THE NETWORK

The VT key function has been modified to allow a remote station user to program a VT key with the group number of the centralized voicemail (which resides in a different node). This enhancement will allow stations in the main or branch offices to transfer calls across the network directly into personal mailboxes of users anywhere in the network, regardless of where the centralized SVMi voicemail card is. The operation will remain the same as a standalone node. The user with a call in progress will press the network VT key, and then dial a mailbox number. For example, the user with a call in progress will press the network VT key, and then dial a specific user's extension number. The caller is then transferred directly to the specified user's personal greeting.

Notes:

- This Network VT key functionality requires the use of the SVMi centralized voicemail feature.
- MMC 825 USE REMOTE VM must be turned on in the nodes remote to the centralized voicemail hardware before the VT key in the remote nodes can use the station group number of the node with the SVMi card.
- MMC 722/723 (program VT key with centralized voicemail station group extender, for remote nodes).
- This feature is supported over Q-sig and IP networking.

MMC INFORMATION:

- [MMC 825](#) (set to "USE REMOTE VM=ON", in remote nodes)
- [MMC 825](#) (set to "REMOTE VM NUMBER XX-XX", in remote nodes)

NETWORKING MESSAGE KEY WITH LED INDICATIONS

This feature permits station users to set a message wait indication to remote stations in the network. When calling a remote station and receiving busy or no answer condition, the caller can press the MSG softkey in the display (or dial the MSG access code) and leave an indication that a message is waiting. The message key will flash red at the remote station receiving the message notification. The remote station can then press the message key to see which station left the message. The remote station user can then press reply to return the call to the station that set the message.

Notes:

- Single line telephones will receive a distinctive message waiting dial tone.
- A maximum of five messages can be sent to a network station MW key.
- In order for this feature to work properly, the feature access code for message waiting must be the same for every node in the network.
- This feature is supported over Q-sig and IP networking.

MMC INFORMATION:

- [MMC 722](#) (assign MSG key)
- [MMC 724](#) (Feature access code, MSG=XX)

NETWORK PAGING

The feature allows station users to assign and page other page zones in other nodes in the network. The main requirement for this feature to work is each node must be programmed to have a unique network page access code or a network page (NP) key. An example would be to program a Network page key as NP023. When a user presses this key, a internal zone page will be made to all member of zone 3 in node 02. The step for accessing a network page group is:

Network paging using access code: Go offhook, dial XX+NN+Z= Paging across the network
 OR

Network paging using NP key: Press the selected NP(NNZ) key = Paging across the network.

XX = (two digit network Page access code)

NN = (two digit item entry assigned in MMC 820)

Z = (One digit page access code, see chart below)

Internal Zone Paging	External Zones
= All Internal Zones	5 = External Zone
1 = Internal Zone	6 = External Zone
2 = Internal Zone	7 = External Zone
3 = Internal Zone	8 = External Zone
4 = Internal Zone	9 = All External Zones

* = All Internal/External Zones

Notes:

- Multiple NP keys can be programmed per keyset in MMC 722.
- Pages can be made to page groups in other nodes; however, stations from other nodes in the network cannot exist in a local page group.
- NP keys can be programmed in MMC 722/723 with or without the extenders.
- This feature is supported over Q-sig and IP networking.

MMC INFORMATION:

- [MMC 722](#) (program NPAGE key to keysets)
- [MMC 724](#) (program NPAGE feature access code)

REMOTE HOLD ACROSS THE NETWORK

The purpose of the remote Hold feature is to allow a user to place a trunk call on exclusive hold at another station in another node. This is called Remote Hold because it is on hold at a station other than yours. To do this, a user (ext. 2001) talking on a CO line, initiates a transfer to another station in another node. Press TRSF, receive dial tone, then dial the extension number (3001). When you hear ring back tone press the HOLD key. This places the trunk call on hold at the remote station (3001). The user then can use the designated Network Page key to make an announcement that the caller is holding on station 3001.

At this point the user at ext 3001 simply takes the call off hold and begins speaking. When the user is not near his station when he hears the page announcement he can go to another station and dial the Hold Pick up code 12 + 3001.

Note: A CO call cannot be put on Remote Hold at a virtual extension in another node. It can be put on Remote Hold at a virtual extension within the same node.

MMC INFORMATION: NONE

CALL PICKUP ACROSS THE NETWORK

This feature enhancement allows ringing calls, recalls and held calls to be picked up by other stations across the network. A station user in the main office can use the directed pick-up, hold pickup or page/park pickup codes to answer calls from the main or branch offices. An example would be a call is answered at the branch office. The call is then parked. The station user performs an internal page to all members in the main office and announces that the call is parked for pickup. Any user can respond to the page by going to any station in the main office and dialing the page pickup access code to remove the caller from hold in the branch office location.

Notes:

- Directed call pickups, hold pickups, and park pickups are all supported over the network.
- This feature is supported over Q-sig and IP networking.
- When CID is present, the CID information is passed across the network.

MMC INFORMATION:

[MMC 722](#) (set DIRPK, HPK, and PAGPK keys)

[MMC 724](#) (set directed pickup, hold pickup, and page/park pickup access codes)

NETWORK SELECTION AND BUSY LAMP FIELD INDICATION ACROSS THE NETWORK

Programmable keys can be assigned as NS/BLF keys that will function across the network. A station with NS/BLF keys in can programmed with station numbers from other nodes within the network. The NS/BLF keys will provide a visual status indication to the associated station. The NS/BLF key will be off when that associated station is idle, will light red when the station is in use, and will flash when the station is in DND. The station user can press a programmed Network Selection key to call or transfer to a station user in other nodes in the network. The steps for accessing an NS/BLF key are:

NSS/BLF NS key: Press the selected NS(XXXX) key = Place call to selected station across the network.

XXXX = (3 or 4 digit network station number)

Notes:

- NS/BLF keys can be programmed on any keyset or add-on module.
- This feature is not supported over PRI Q-sig. This feature requires a LAN connection.
- Network stations are supported on NS keys, but virtuals and station group numbers cannot be associated with NS Keys.
- Any keyset user can have multiple NS keys with different extenders.
- The NSS keys can be used to answer ringing calls from the associated station.
- A visual indication is provided when the associated station is ringing, but no audible indication is presented.
- The network selection keys can be used for directed call pickup across the network if this feature option is activated in MMC 210, DSS KEY DPU set to ON in the NODE where that ringing station is physically connected.

MMC INFORMATION:

- [MMC 722/723](#) (set NS key to keysets)
- [MMC 210](#) (DSS KEY DPU)

ADDITIONAL ENHANCEMENTS

Call Coverage Key

The call coverage key (CC key) is a feature where one station can visually and/or audibly monitor the call status of another, or several other stations, and serve as a backup answering position of other stations users. The secretary can monitor (and answer) the call status of several executives. For example, an incoming call would begin to ring at the executive's telephone. After a pre-programmed time period, the call would continue to ring the executive, but would also delay ring to a programmed Call Coverage key on the secretary's station. The secretary can press the associated Call Coverage key to answer the call for the executive. The steps to accessing a CC key are as follows: Call coverage is a single node feature. The feature is not supported across the network.

CC key: Press the selected CC(XXXX) key = Answer delayed ringing call for another station.

XXXX = (3 or 4 digit station)

Covered Station Status	Covering Station LED Indication
Ringing on CO	Fast Flash Green
Ringing on intercom call	Fast Flash Green
Transfer/Hold Recall	Fast Flash Amber
Busy	Steady Red
In DND	Flashing Red
Idle	LED OFF

Notes:

- Call Coverage only works for stations in a standalone node. Call coverage will not work for virtuals extensions, or station groups. Call Coverage also does not support stations, virtuals, or station groups in other nodes.
- A call cannot be transferred using the call coverage key
- The call coverage key cannot be used as a direct station selection (DSS) key.
- When programming MMC 722/723, the extension of the call coverage key can only be programmed using station numbers from the local node. Stations, station groups or virtual numbers from remote nodes cannot be used.
- If the CC delay ring timer is set to 000 (MMC 502) the CC key will ring immediately.
- The CC delay timer is programmable on a per station basis.
- If the station user is busy, there will not be any offhook ringing audible for a CC key.
- The call coverage key can be used to perform directed call pickups.
- Calls ringing on the CC key will not follow the covering station's call forwarding, but will follow the forwarding of the original or covered station.
- Hold recalls and transfer recalls to the covered stations will also recall to the covering station. The CC key will flash amber during transfer/hold recalls.

- This feature is not supported over the network.

MMC INFORMATION:

- [MMC 722/722](#) (set CC keys to keysets)
- [MMC 502](#) (set CC RNG DLY timer, set on a per station basis)

PROIRITY CALL ROUTING

This new feature allows certain calls queuing to station groups to be given a higher priority over other calls already in the queue. This is a very useful enhancement to customer service organizations. Business owners can offer improve customer service and reduced hold time for their most preferred customers. An example of this is: Six calls are holding in a queue. The seventh call arrives into queue. The DID information from the telco identifies this caller as a preferred customer. This preferred customer has been designated a higher priority. This customer will be removed from the seventh spot in the queue and move to the first position in queue. Another example of how priority call routing can be used is a call to the branch office is queued to a busy station group. After a predetermined time, the call is overflowed from the branch office station group to the main office. When the call arrives at the station group in the main office, it is designated a higher priority because it has already been in queue at the branch office for a long time. The higher priority overflow from the branch office is now move up in the queue and answered immediately. The next available agent will receive the priority call from the preferred customer. Priority routing can be assigned by the incoming DID number, the Caller ID, or on a per trunk basis.

Notes:

- Priority call routing is supported on analog and digital trunks.
- Priority routing can be set on each DID number or each Caller ID line or trunk port.
- From 1 to 9 priority levels can be set per call with 1 being the highest priority.
- Call priority can be set to station or station groups within the local node only.
- Priority calls can be set to normal or UCD groups, but not to VM/AA/MSG groups.
- The settings for priority call routing in MMC 759 will take precedence over distinctive ringing settings in MMC 419.

DISTINCTIVE RINGING

This existing feature has been enhanced to allow each stations or trunk to assign and send a distinct ring tone to any station receiving the incoming call. When specified trunks or stations are assigned to distinctive ring, a different audible tone and cadence will be heard at the station receiving the incoming call. This will allow the receiving station users to identify one incoming caller from another by the audible sound. An example of how this may be used is the receptionist is answering many incoming calls and transferring the calls to other stations. She is expecting a call from the boss. When the boss calls in using his mobile phone, the system will recognize the bosses caller ID and provide a unique audible tone and ring pattern.

Now the receptionist can positively identify the call of the boss and answer the call immediately with a personalized greeting. This feature can be set on a per node basis.

Notes:

- Distinctive ringing is assigned on a per station, per trunk basis.
- There are eight different ring tones available for distinctive ringing.
- There are 5 cadences (ring patterns) available for digital and single line telephones.
- This feature is not supported over the network.

MMC INFORMATION:

[MMC 759](#) (set CID Priority)

[MMC 714](#) (set DID Priority)

[MMC 419](#) (set TRUNK Priority)

2.10 OFFICESERV CONNECT AND MOBEX

The OfficeServ Connect, MOBEX, and Executive MOBEX features are a part of the Samsung Fixed Mobile Convergence solution. These 3 distinct features can be used separately, or combined together. This provides maximum flexibility and customization.

MOBEX

MOBEX, short for Mobile Extension, is a feature that allows you to assign a local 2, 3, or 4 digit extension to a telephone that is not a part of the OfficeServ system. This can be a cell phone, home phone, or any other phone number. This is very similar to a speed dial, except that MOBEX ports can be assigned to DSS keys, placed in Station Groups, and even have a DID routed to them. The diagram below show the basics of MOBEX:

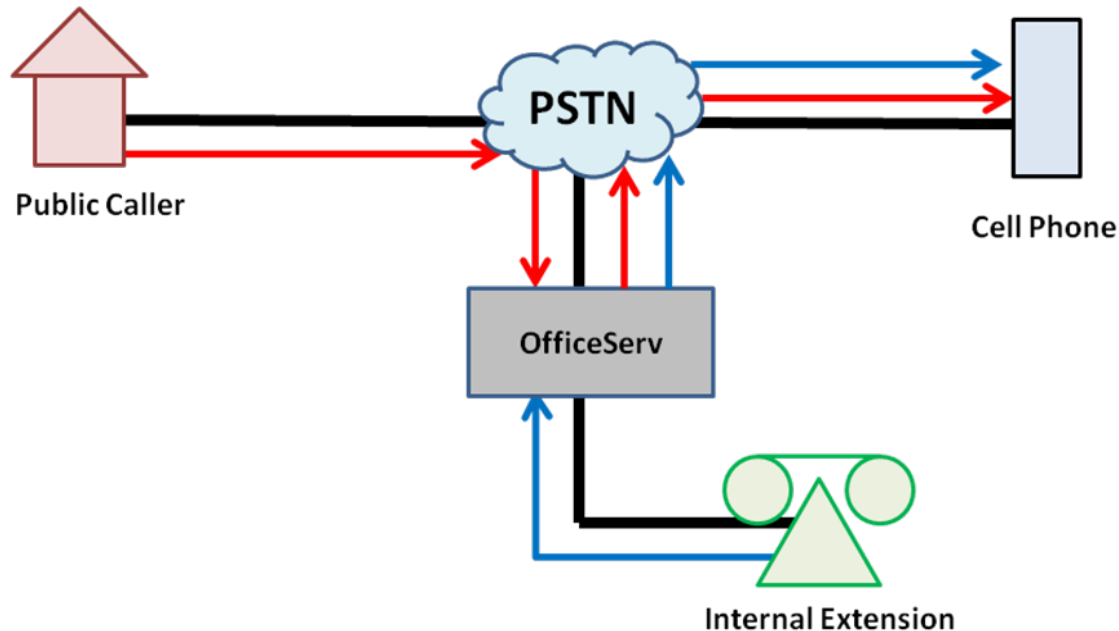

Call to Mobile Extension

- 1. CO Call to Mobile Extension displays CID of Public Caller**
- 2. Intercom call to Mobile Extension displays CID of Extension**

The red arrows show the call flow of a CO call. The public caller dials a DID number which has a destination of a MOBEX port (in this case a cell phone). When the call reaches the cell phone the call will display the caller ID of the public caller.**

The blue arrows show the call flow of an intercom call. The internal extension dials the 2, 3, or 4 digit MOBEX port number and the call is routed automatically to the cell phone. When the

call reaches the cell phone the call will display the extension number of the internal extension user.**

Executive MOBEX

Executive MOBEX is an optional, licensed enhancement to the MOBEX feature. Executive MOBEX is used to assign MOBEX DSP to a selected MOBEX port. These MOBEX DSPs are a special type of DTMF Receiver that will connect to any calls made to or from the MOBEX port. These MOBEX DSPs allow the Executive MOBEX user to dial a code during a call on their Mobile Extension and receive system dial tone back so they can perform call control activities such as transferring the call, setting up a conference, or placing the caller on hold at another keyset. In addition, Executive MOBEX allows a special DID to be set up that allows Executive MOBEX users to call in to the system from their Mobile Extension and receive system dial tone in order to place calls through the system. This is simply a variation of the DISA feature. The diagram below shows the call flow for an Executive MOBEX call:

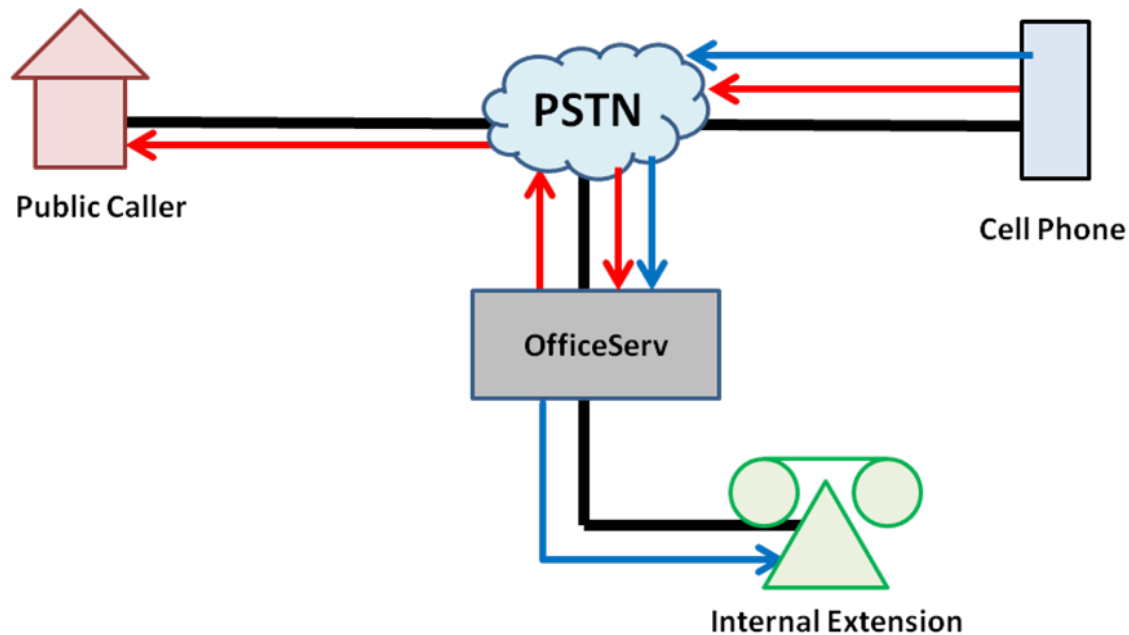

Call from Executive Mobile Extension

- 1. Call to CO will display CID of MOBEX port instead of Cell Phone**
- 2. Call to Internal Extension will show MOBEX Extension as CID**

The red arrows show a call from the Executive MOBEX user to an external party by calling into the OfficeServ system. This allows the user to make a call from the Mobile Extension without the called party seeing their cell phone's CID. This is because the caller will instead see the CID of the MOBEX port itself, which can be set in MMC 321.

The blue arrows show a call from the Executive MOBEX user to an Internal Extension. By calling in to the OfficeServ system the user can dial the 2, 3, or 4 digit Extension number and reach the Internal Extension without displaying their cell phone number. Instead the system will show the Internal Extension user the 2, 3, or 4 digit MOBEX port number as CID instead.

OfficeServ Connect

The OfficeServ Connect feature allows simultaneous ringing of a Master keyset and up to 5 other devices. These devices can be internal keysets (SLT, DLI, WIP, ITP, SIP Stations, etc) as well as MOBEX ports. This means that when combined with the MOBEX feature, OfficeServ Connect allows calls to ring at a keyset and a cell phone (or other external device) simultaneously. When one device answers the call, the other devices stop ringing. If no device answers the call within the Master keyset's No Answer Forward time the call is routed to the Master keyset's voicemail. The diagram below shows the call flow for OfficeServ Connect:

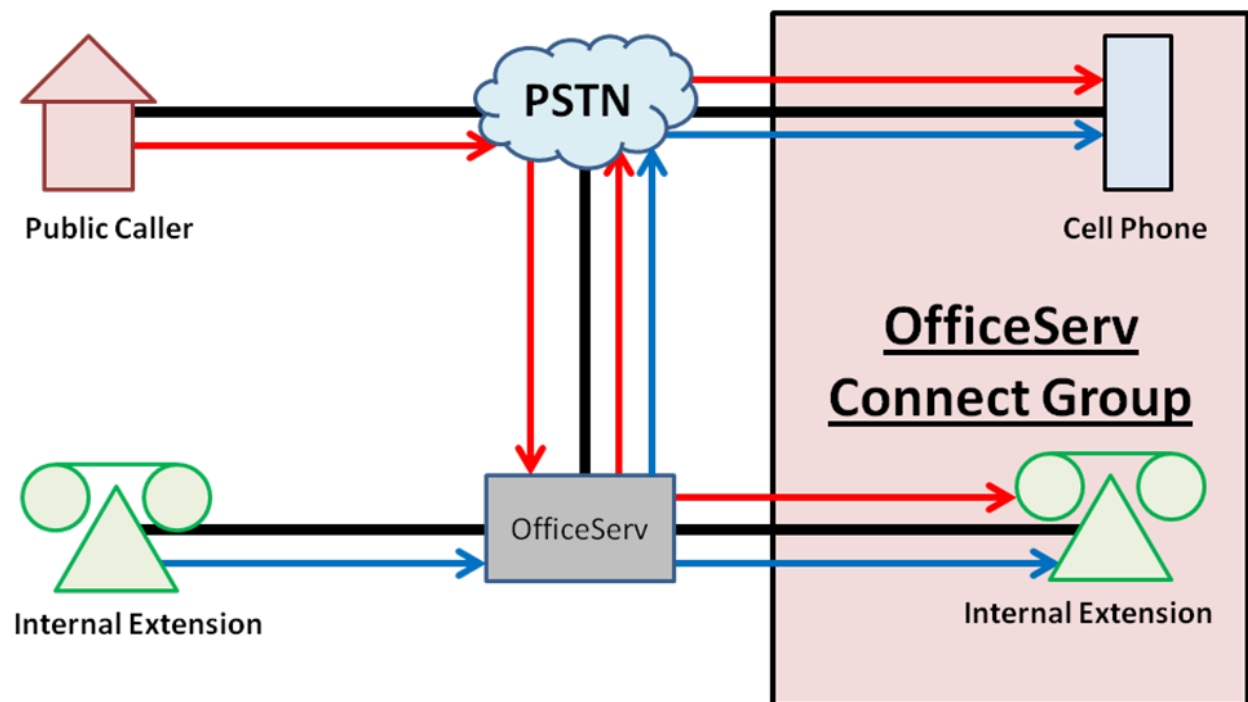

Simultaneously Ring Multiple Numbers (Max 5)

- 1. Incoming CO Call to Multiple Telephone Numbers**
- 2. Intercom call to Multiple Telephone Numbers**

The red box shows that the Internal Extension and MOBEX cell phone are set up in an OfficeServ Connect group. This means that when an internal or external call is made to the Internal Extension (the Master keyset of the group) it will ring at both the keyset and the cell phone simultaneously. The call can be answered at either location.

NOTE: MOBEX requires the use of PRI/SIP trunking. Executive MOBEX requires a valid Executive MOBEX license as well as an OAS card configured to allow MOBEX DSPs in MMC 858.

****:** The public caller or internal extension caller ID can only be sent to the MOBEX port if your PRI/SIP service provider allows it. Some PRI/SIP providers only allow outbound calls to send the caller ID of a number than bills to them. In these cases you must choose a number that will be sent for all MOBEX calls.

A SAMPLE APPLICATION (STEP BY STEP)

A customer site of yours has 4 sales people who work 1 day a week in the office and spend the rest of their time travelling. When potential clients call in they are routed to a group that contains 4 keysets belonging to these sales agents. When calls aren't answered they go to a general delivery mailbox that is checked hourly by the on-call agent. The customer would like you to provide a more efficient solution to this scenario.

PLANNING:

There are a few aspects of this scenario to consider:

- Callers come in to a group
 - This means that setting all call forwarding on each agent's phone isn't a good solution because no group calls would ever get to an agent (group calls can't follow station forwarding).
- Each agent spends more time out of the office than in
 - This means the solution has to center around the agent being out of the office instead of in the office.
- They need to process calls in and out of the office easily
 - This means the solution has to transition from being local to being away easily. IP phone / Softphone use isn't a good fit here because the user would have to reprogram the server IP address each time they came into or left the office.
- Each agent needs access to the group delivery mailbox
 - This means all agents will need some kind of alerting when a message is left.

This allows us to flesh out which features and/or programs we need to set up:

- Callers come in to a group
 - We need to set up a DID in MMC 714 that rings to a station group in MMC 601 that contains all agent phones (2011 – 2014)
- Each agent spends more time out of the office than in
 - A MOBEX port will allow them to process calls remotely, so each agent will need a MOBEX port

- They need to process calls in and out of the office easily
 - They will have a local extension, so they will need OfficeServ Connect turned on to allow calls to ring to their keyset and their MOBEX port simultaneously
 - They will need to be set as Executive MOBEX users to allow them to make calls from their Mobile Extension through the system.
 - In order to use Executive MOBEX you will need a license for 4 Executive MOBEX users.
- Each agent needs access to the group delivery mailbox
 - The Samsung Voicemail will need the general delivery mailbox to be a LIST box that distributes messages to the 4 agents' mailboxes and each mailbox will need Message Alert enabled to call their MOBEX extension when messages are left.

PROGRAMMING:

Armed with the above knowledge we can now begin programming. For the purposes of this sample we will skip the voicemail programming. Consult your voicemail documentation for details on how to set up a general delivery mailbox.

1. Configure the DID in [MMC 714](#): set a digit of 1234 to ring group 5005 for all 6 ring plans.
2. Configure group 5005 in [MMC 601](#): set the type to Normal, the ring type to Distributed, the Next Hunt timer to 20 seconds, the Next Port to voicemail, and an overflow of 120 seconds. This will give agents ample time to answer the call before sending them to the group mailbox.
3. In [MMC 724](#) set up 4 MOBEX ports: Port 1 = 3011, port 3 = 3012, port 5 = 3013, and port 7 = 3014. Note that only odd-numbered MOBEX ports get directory numbers. This is because each MOBEX call uses up two MOBEX ports, so the even-numbered ports do not require directory numbers as they are not user-accessible. Also set the MOBEX Feature Code. For this example we will use *8 as the MOBEX feature code.
4. In [MMC 329](#) set a MOBEX port to member 1 of each station's OfficeServ Connect group: 2011 -> 3011, 2012 -> 3012, etc. This will allow calls to ring the desk phone and cell phone simultaneously.
5. In [MMC 328](#) configure the MOBEX ports to dial the cell phones: set the TEL NUMBER field to dial trunk group 801 (the default PRI trunk group) and the 7 or 10 digit cell phone number. This will allow the cell phones to be called when the MOBEX directory number is dialed.

6. In MMC 860 enter the Executive MOBEX license
7. In MMC 328 set each of the 4 MOBEX ports to be Executive users. In the CLI field enter the 7 or 10 digit cell phone number. Set the Master station to the corresponding station from MMC 329 (2011 for 3011, etc). This will assign the MOBEX ports as Executive MOBEX users.
8. In MMC 714 create a back door DID number that the agents can call in to in order to make calls through the switch. Set the Destination of this DID to *8. For this example we will use the DID 972-555-1234
9. In [MMC 722](#) place a MOBEX button on each of the 4 stations (2011 – 2014). This will allow the agents to turn their OfficeServ Connect ringing on and off with a one-touch key.

That is all the programming that is necessary. Calls that ring to the group will ring to an agent's keyset and cell phone for 20 seconds and then ring to the next agent. If no agent answers within 2 minutes the caller will go to the general delivery voicemail box. When an agent is in the office they can press their MOBEX button to disable the ringing at their cell phone without having to adjust group parameters or affect their voicemail forwarding. When the agent answers the call on their Mobile Extension they can press *8 to receive system dial tone and transfer the caller back to the office. In addition, they can dial 972-555-1234 from their cell phones to receive system dial tone that will allow them to make calls as if they were in the office.

2.11 SIP CONNECTIVITY TO 3rd PARTY ATA DEVICES

The OfficeServ 7000 series can be connected to 3rd party analog terminal adapter (ATA) for special applications such as remote IP Phones requiring local 911 emergency services, local 411 directory assistance, remote fax machines and/or analog phone deployment. This document will describe, in general, how to connect the ATA via SIP protocol to any of the OfficeServ 7000 series platforms. This document outlines deployment of the following specialized applications:

- Routing 911 calls over SIP peering from (remote) IP phone to 3rd party (local) FXO device.
- Routing to remote Fax station or Analog stations from the OfficeServ to 3 party ATA via SIP.

1. Remote 911 Routing from IP Phone to 3rd Party SIP FXO Device

The first specialized application discusses when remote IP workers are physically located in a different exchange or area code than the main OfficeServ system, but requires 911 emergency calls dialed from the IP phone must to be re-routed to the local exchange of the IP phone for emergency services. In this case there are 3 possible solutions:

Notes:

1. *If SIP trunking is available, many SIP service providers offer this as an additional service that can route 911 calls from the SIP server to the appropriate local exchange of the IP phone. This is the preferred solution. Contact your VoIP/SIP service provider for more details.*
2. *A second OfficeServ 7000 series system can be connect at the remote site (eg; OS7100) and can support the 911 routing to the local exchange via SIP peering.*
3. *A 3rd party ATA can be used and SIP peered to the OfficeServ 7000 series system to route 911 emergency calls to the local PSTN.*

The following instructions will explain option 3: The OS 7000 system with remote ITP phone, dialing 911, routing via SIP peering to 3rd Party ATA, with FXO (loop start trunks).

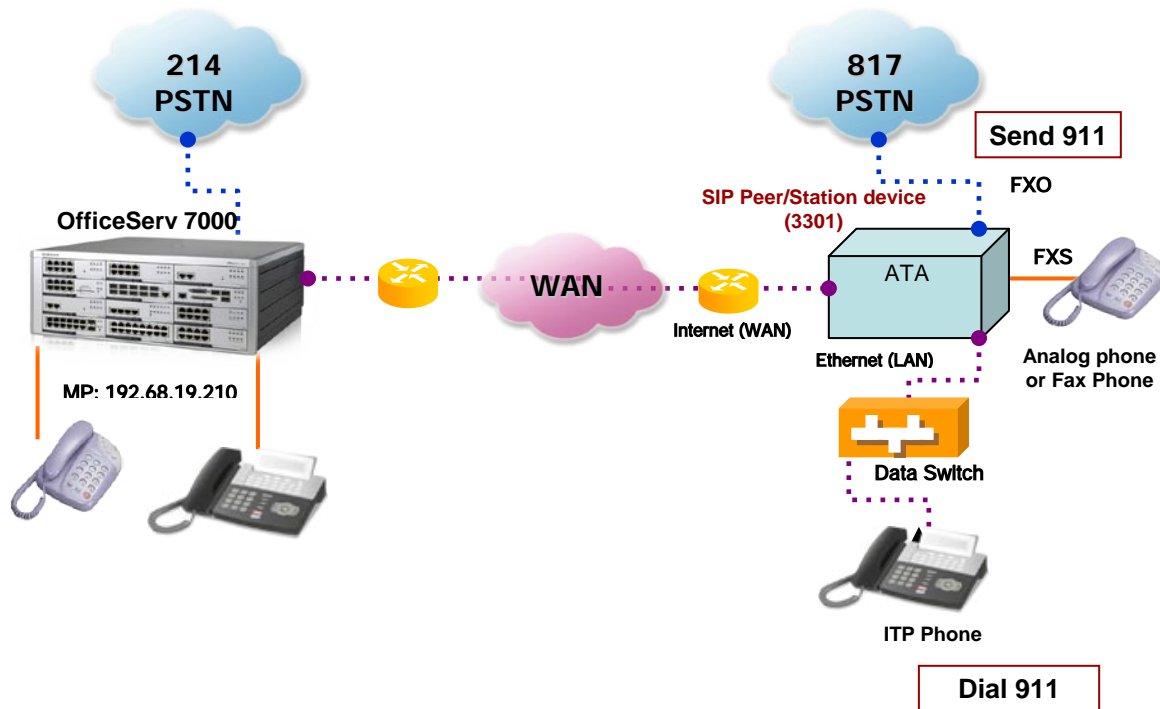

1.1 Three Step Approach:

1. Program the OfficeServ to support SIP trunks and Stations (SIP licenses required).
2. Program the OfficeServ to support remote ITP phones on public network.
3. Plug in and configure the Linksys 3102 ATA to register to the switch as a SIP Peering and Station device on the public network.
4. Program the OfficeServ to route emergency calls (911) dialed from the remote IP phones over the IP network (main switch) to the FXO port of the remote ATA adapter.

Notes:

1. The remote ITP phone and ATA should be programmed and working on the public side of network.
2. The ATA must support SIP peering.
3. Only a static IP address must be used in the ATA WAN setting.

1.2 OfficeServ Programming for SIP Services:

The first requirement is to make certain the OfficeServ system is at software version 4.30d or higher and the system is configured to support SIP peering/stations and remote IP stations on public network. This can be done by setting the following MMC:

- MMC 860 (Enter SIP License Key)
 - MMC 857 (Set virtual slots for SIP trunks and stations).
 - MMC 199 (Check SIP license Status)
-

1.3 3rd Party ATA Setup:

1. First, Plug you PC into the Ethernet port of the ATA, open up an Internet browser and log into the Administrative web Server of the ATA adapter.
2. Determine the address of the administration web server (example: 192.168.0.1). Direct the browser to the IP address of the ATA.

Three areas will have to be setup: Router (WAN setup), Line 1(SIP extension), and PSTN line (SIP Peer).

Note: This document is written using examples of IP addresses. During the actual installations, use the valid IP addresses from the customer's on premise network.

Step 1 Login to > Wan Setup: (Internet) Set the following:

>Internet connection Settings

Connection Type: Static IP

>Static IP settings

Static IP: 215.61.85.191

Gateway: 215.61.85.1

NetMask: 255.255.255.127

Then click on the ***“Submit or Save”*** button on the bottom of the web page.

Note: All other settings should remain at default.

Step 2 Login to > Line 1 (SIP Station setup)

>SIP Settings

SIP port: 5061 (make port different than SIP peer)

>Proxy Registration

Proxy: 192.67.8.209 (MP System Public IP address in MMC 830)

>Subscriber Information

Display Name:	3302	User ID:	3302
Password:	0000	Use Auth ID:	YES
Auth ID:	3302		

>Auto Configuration

Preferred Codec: G729a (Should match MGI codec setting of MMC 835).

Then click on the **"Submit or Save"** button on the bottom of the web page.

Note: All other settings may remain at default.

Step 3 Login to > PSTN Line: (SIP Peering)

>SIP Settings

SIP port: 5060 (make port different than SIP station)

>Proxy Registration

Proxy: 215.61.85.201

>Subscriber Information

Display Name:	3302	User ID:	3302
Password:	0000	Use Auth ID:	NO
Auth ID:	3302		

>VoIP to PSTN Gateway Setup

VoIP to PSTN Gateway Enable: yes One Stage Dialing: yes

Then click on the **"Submit or Save"** button on the bottom of the web page.

Note: All other settings may remain at default.

Check MMC 842 of the OfficeServ to verify that the ATA device is registered.

(EXAMPLE)

<i>1st Display:</i>	<code>[3302]REGISTERED</code>	<i>2nd Display:</i>	<code>[3302] IP ADDRESS</code>
	<code>YES</code>		<code>215.61.85.191</code>

1.4 OfficeServ Programming

Configuring the OfficeServ for Emergency 911 routing from IP Phone

In order for this application to work, the OS7000 system must have SIP licenses to enable the required SIP stations and SIP trunks. The instructions are written using the examples of how to setup for IP station 8955 and SIP peer/station 3302 registered to static IP address 215.61.85.191.

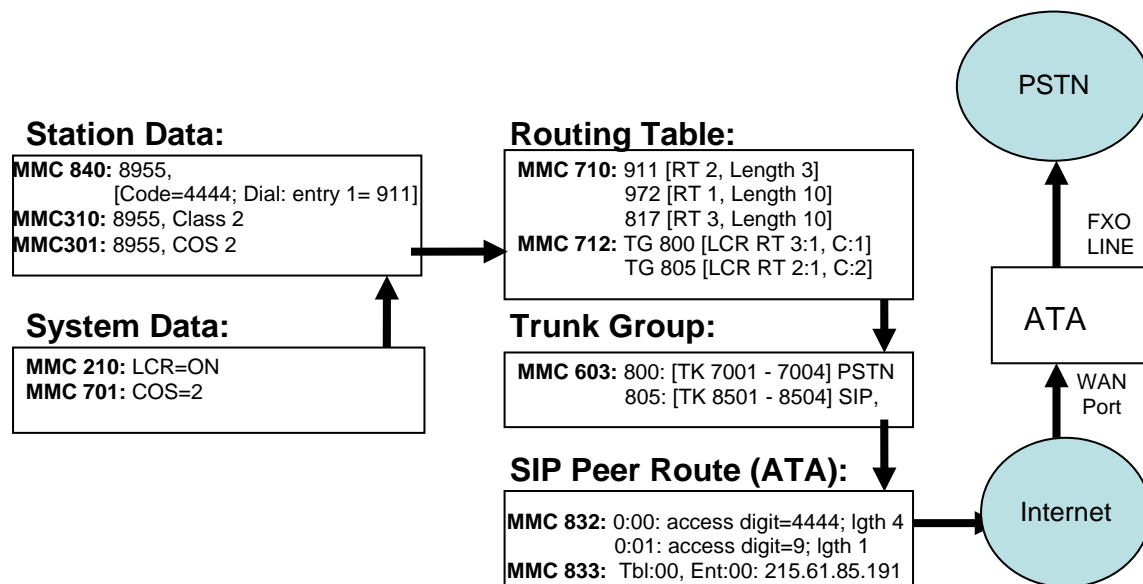

- IP Station: **8955**
- Dialing Digits: **911** Emergency Code : **4444**
- Trunk Group: **805** (SIP Trunks)
- SIP peer (**Route 2**) to ATA adapter (IP: 215.61-85.191)

- MMC 210:** LCR ENABLE: ON
- MMC 310:** ITP Phone **8955** → Set to LCR CLASS 2
- MMC 301:** ITP Phone **8955** → COS to 02
- MMC 701:** COS=02, TRK GROUP ==> Set PSTN Trunk Group as "YES"
- MMC 603:** Set Trunk Groups, Trunk dial "9" (Trunk Group 800)

(Local PSTN) Trunk Group 800: 701 ~ 708

(Remote PSTN) Trunk Group 801: 701 ~ 708

(SIP RT) Trunk Group **805: 8501 ~ 8504**

	800	801	805
Trunk Group	Local PSTN	Remote PSTN	SIP Peer
Member 1	701	701	8501
Member 2	702	702	8502
Member 3	703	703	8503
Member 4	704	704	8504

- **MMC 710:** LCR DIGIT: 911, **RT: 02** (remote **911** service via SIP peering)
- LCR DIGIT: 817, RT: 03 (remote PSTN)
- LCR DIGIT: 214, RT: 01 (local PSTN)

Table #	Digits	length	Route
0001	911	3	2
0002	817	10	3
0003	214	10	1

- MMC 712:** LCR ROUTE (01:1)
C: 1 G: 800 M: ---; CLASS 1 => Local PSTN trunk group (ex.800)
 LCR ROUTE (02:1)
C: 2 G: 805 M: ---; CLASS 2 => SIP trunk group (ex.805)
 LCR ROUTE (03:1)
C: 1 G: 801 M: ---; CLASS 1 => Remote PSTN trunk group (ex.801),

Route	Class	Group	Modify
01:1	1	800	---
02:1	2	805	---
03:1	1	801	---

- **MMC 830:** System IP address: System IP Type: Private w/ Public
 System Public IP (eg; 215.61.85.202)
- **MMC 831:** MGI IP address: MGI IP Type: Private w/ Public
 MGI Public IP: (eg; 215.61.85.202)
- **MMC 832:** Set VOIP Routing TB after input EMGY CODE at ACCESS DGT field.
 (0:00) ACCESS DGT: **4444**

Table	entry	Access Digit	Insert Digit	Digit length
0	000	4444	---	4
0	001	9	---	1

- **MMC 833:** Set IP Address of SIP-FXO at Table Index.
 Table (000) Entry (ADDR 1): **215.61.85.191** (same as ATA WAN setting)
 Protocol: **SIP**
 RMT Port: **5060**
 SIG TYPE: **UDP**

Table 000(ADDR 1)	215.61.85.191
Protocol	SIP
Remote port	5060
SIP signal type	UDP

- **MMC 840:** Set EMGY CODE (ex.**4444**) and EMGY DIAL (ex.**911**)
 of ITP (8955)

Tel #	User ID	pwd	IP ADDR	IP Type	DSP Type	Emerg code	Emerg Dial 1
8955	8955	1234	215.61.85.190	Private w/ pub	G.729a	4444	911

2.2 ATA Setup for Remote SIP FAX or Analog Station

Note: When using the ATA's FXS port for fax machine, also enable the T.38 fax setting on the ATA.

Step 1 Login to > Wan Setup: (Internet) Set the following:

>Internet connection Settings

Connection Type: Static IP

>Static IP settings

Static IP: 215.61.85.191

Gateway: 215.61.85.1

NetMask: 255.255.255.127

Then click on the **"Submit or Save"** button on the bottom of the web page.

Note: All other settings should remain at default.

Step 2 Login to > Line 1 (SIP Station setup)

>SIP Settings

SIP port: 5060

>Proxy Registration

Proxy: 215.61.85.202 (MP System Public IP address in MMC 830)

>Subscriber Information

Display Name: 3302

User ID: 3302

Password: 0000

Use Auth ID: YES

Auth ID: 3302

>Auto Configuration

Preferred Codec: G729a (Should match MGI codec setting of MMC 835).

Then click on the **"Submit or Save"** button on the bottom of the web page.

Note: All other settings may remain at default.